



FAI Sporting Code

*Fédération
Aéronautique
Internationale*

Section 4 – Aeromodelling

Volume F3 Radio Control Model Helicopters

2010 Edition

Effective 1st January 2010

F3C – RC HELICOPTERS
ANNEX 5D – F3C MANOEUVRE DESCRIPTIONS & DIAGRAMS
ANNEX 5E – JUDGES' GUIDE
ANNEX 5F – CLASS F3N (Provisional)

*Avenue Mon-Repos 24
CH-1005 Lausanne
(Switzerland)
Tél.: +41(0) 21/345.10.70
Fax: +41(0) 21/345.10.77
E-mail: sec@fai.org
Web: www.fai.org*

FEDERATION AERONAUTIQUE INTERNATIONALE

Avenue Mon Repos 24, 1005 LAUSANNE, Switzerland

Copyright 2010

All rights reserved. Copyright in this document is owned by the Fédération Aéronautique Internationale (FAI). Any person acting on behalf of the FAI or one of its Members is hereby authorised to copy, print, and distribute this document, subject to the following conditions:

- 1. The document may be used for information only and may not be exploited for commercial purposes.**
- 2. Any copy of this document or portion thereof must include this copyright notice.**

Note that any product, process or technology described in the document may be the subject of other Intellectual Property rights reserved by the Fédération Aéronautique Internationale or other entities and is not licensed hereunder.

RIGHTS TO FAI INTERNATIONAL SPORTING EVENTS

All international sporting events organised wholly or partly under the rules of the Fédération Aéronautique Internationale (FAI) Sporting Code¹ are termed *FAI International Sporting Events*². Under the FAI Statutes³, FAI owns and controls all rights relating to FAI International Sporting Events. FAI Members⁴ shall, within their national territories⁵, enforce FAI ownership of FAI International Sporting Events and require them to be registered in the FAI Sporting Calendar⁶.

Permission and authority to exploit any rights to any commercial activity at such events, including but not limited to advertising at or for such events, use of the event name or logo for merchandising purposes and use of any sound and/or image, whether recorded electronically or otherwise or transmitted in real time, must be sought by way of prior agreement with FAI. This includes specifically all rights to the use of any material, electronic or other, that forms part of any method or system for judging, scoring, performance evaluation or information utilised in any FAI International Sporting Event⁷.

Each FAI Air Sport Commission⁸ is authorised to negotiate prior agreements on behalf of FAI with FAI Members or other entities as appropriate, of the transfer of all or parts of the rights to any FAI International Sporting Event (except World Air Games events⁹) which is organised wholly or partly under the Sporting Code section¹⁰ for which that Commission is responsible¹¹. Any such transfer of rights shall be by “Organiser Agreement”¹² as specified in the current FAI Bylaws Chapter 1, paragraph 1.2 “Rules for Transfer of Rights to FAI International Sporting Events”.

Any person or legal entity which accepts the responsibility for organising an FAI Sporting Event, whether or not by written agreement, in doing so also accepts the proprietary rights of FAI as stated above. Where no formal transfer of rights has been established, FAI retains all rights to the event. Regardless of any agreement or transfer of rights, FAI shall have, free of charge for its own archival and/or promotional use, full access to any sound and/or visual images of any FAI Sporting Event, and always reserves itself the right to have any and all parts of any event recorded, filmed and/or photographed for such use, without charge.

1 FAI Statutes, Chapter 1, para. 1.6

2 FAI Sporting Code, General Section, Chapter 3, para 3.1.3

3 FAI Statutes, Chapter 1, para 1.8.1

4 FAI Statutes, Chapter 2, para 2.1.1; 2.4.2; 2.5.2; 2.7.2

5 FAI Bylaws, Chapter 1, para 1.2.1

6 FAI Statutes, Chapter 2, para 2.4.2.2.5

7 FAI Bylaws, Chapter 1, para 1.2.3

8 FAI Statutes, Chapter 5, para 5.1.1; 5.5; 5.6

9 FAI Sporting Code, General Section, Chapter 3, para 3.1.7

10 FAI Sporting Code, General Section, Chapter 1, paras 1.2. and 1.4

11 FAI Statutes, Chapter 5, para 5.6.3

12 FAI Bylaws, Chapter 1, para 1.2.2

PAGE DELIBERATELY LEFT BLANK

VOLUME F3 HELICOPTERS

SECTION 4C – MODEL AIRCRAFT – F3 HELICOPTERS

Part Five – Technical Regulations for Radio Controlled Contests

5.4. F3C, Helicopters

Annex 5D – F3C Manoeuvre Description & Diagrams

Annex 5E – Judges' Guide

Annex 5F – F3N, Helicopters (Provisional)

THIS 2010 EDITION INCLUDES THE FOLLOWING AMENDMENTS MADE TO 2009 CODE

These amendments are marked by a double line in the right margin of this edition

Paragraph	Plenary meeting approving change	Brief description of change	Change incorporated by
5.4.3	n/a	Corrected formatting to first paragraph and numbered	Technical Secretary
5.4.3.b	2009	Maximum weight with fuel/battery – 6.5 kg	Horace Hagen S/C Chairman
5.4.3.c		Maximum battery voltage – 51 Volts	
5.4.9.		Amend definition of official flight	
5.4.11.		New team classification	
5.4.13.		Correct ABR reference	
Annex 5D, 5E		No engine off during autorotation	
Annex 5E, 5.f.11.1		Corrected the manoeuvre title and diagram to match the text description	
Annex 5D		New manoeuvre descriptions	
Annex 5F		Update of F3N class	

Four-Year Rolling Amendments for Reference			
Paragraph	Plenary meeting approving change	Brief description of change	Change incorporated by
5.4.11.	2008	Return to 1000 point normalisation (was effective 01/05/08)	Horace Hagen S/C Chairman
Pages 5, 6, 7	n/a	Corrected volume name	Technical Secretary
Annex 5 D		2006/07 Manoeuvre Schedule B: text & manoeuvres deleted	
5.4.11.	2007	Clarification for average score calculation	Horace Hagen S/C Chairman
5.4.13.		New paragraph "Interruption of a competition" including consequential text	
5D.4		Manoeuvre C10 – Removed 180 deg pirouette	
ANNEX 5F		Manoeuvre update for provisional class F3N effective 11/05/07	
Rule Freeze	2006	Rule freeze reduced to two years & provisional classes not included in the rule freeze	Horace Hagen S/C Chairman
5D.3 B8		Safety amendment, effective 01/05/06: changed part of the manoeuvre	
Annex 5F – Class F3N		New provisional class with contest layout, manoeuvre descriptions and diagrams	

RULE FREEZE FOR THIS VOLUME

With reference to paragraph A.12 of Volume ABR:

In all classes, the two-year rule for no changes to model aircraft/space model specifications, manoeuvre schedules and competition rules will be strictly enforced, but in step with the World Championship cycle of each category. This means that in Volume F3 Helicopters:

- (a) changes can next be agreed at the Plenary meeting 2011 for application from January 2012;
- (b) provisional classes are not subject to this restriction.

The only exceptions allowed to the two-year rule freeze are genuine and urgent safety matters, indispensable rule clarifications and noise rulings.

VOLUME F3 HELICOPTERS

PART FIVE - TECHNICAL REGULATIONS FOR RADIO CONTROLLED CONTESTS

5.4. CLASS F3C HELICOPTERS

5.4.1. DEFINITION OF A RADIO CONTROLLED (R/C) HELICOPTER

An R/C helicopter is a heavier-than-air model aircraft (MA) that derives all of its lift and horizontal propulsion from a power driven rotor system(s) rotating about a nominally vertical axis (or axes). Fixed horizontal supporting surfaces up to 4% of the swept area of the lifting rotor(s) are permitted. A fixed or controllable horizontal stabiliser of up to 2% of the swept area of the lifting rotor(s) is permitted. Ground effect machines (hovercraft), convertiplanes or aircraft that hover by means of propeller slipstream(s) deflected downward are not considered to be helicopters.

5.4.2. BUILDER OF THE MODEL AIRCRAFT

Paragraph B.3.1.a) of Section 4b (Builder of the model aircraft) is not applicable to class F3C.

5.4.3. GENERAL CHARACTERISTICS

- a) AREA: The swept area of the lifting rotor cannot exceed 250dm^2 . For helicopters with multiple rotors whose rotor shafts are more than one rotor diameter apart the total swept area of both rotors cannot exceed 250dm^2 . For helicopters with multiple rotors whose rotor shafts are less than one rotor diameter apart the swept area of both rotors (counting the area of superposition only once) cannot exceed 250dm^2 .
- b) WEIGHT: The weight of the model aircraft (with fuel / with batteries) must not exceed 6.5 kg.
- c) MOTOR: Maximum piston engine displacement: 15 cm^3 2-cycle, 20 cm^3 4-cycle, 25 cm^3 gasoline only.
Electric motors are limited to a maximum no load voltage of 51 volts for the propulsion circuit.
- d) GYROS: The use of automatic stabilisation devices that utilise external references is forbidden. The use of pre-programmed flight manoeuvres is forbidden. The use of an electronic rate sensor is limited to rotation about the yaw axis.
- e) ROTOR BLADES: All-metal main or tail rotor blades are prohibited.

5.4.4. NOISE LIMIT

Noise level measurements must be made before the start of a competition, preferably during the official practice day. The noise level must be measured at a distance of 3m (3 metre) while the helicopter is hovering with the skids/landing gear at 2m over the centre of a 2m diameter circle. A remote microphone mounted on a tripod must be used. The engine speed (RPM) must be the same as that used during the hovering portion of the flight schedules. During the measurement the helicopter must be rotated through 360° to determine the maximum noise level. The sound pressure level must not exceed 87dB (A) over a soft (grass) surface or 89dB (A) over a hard (asphalt, concrete, etc.) surface. If the noise level limit is exceeded during the first measurement, two additional measurements must be made to substantiate the excessive noise level. The competitor may modify the helicopter and/or silencer system to reduce the noise level and after verification of an acceptable level, will be permitted to fly. If the noise level cannot be reduced to or below the noise level limit it will not be allowed to fly in the competition. The measuring equipment must be calibrated to the dB (A) sound pressure level scale defined in applicable ISO Standards. If noise measuring equipment that can be calibrated to ISO Standards is not available, the measurements will be advisory only and no competitor can be excluded from the competition.

5.4.5. CONTEST AREA LAYOUT

See FIGURE 5.4.A. Note: If two flight lines are used they must be parallel, operate simultaneously, face in the same direction and be separated by a minimum of 500m for a "front-to-back configuration" or a minimum of 1000m for a side-by-side configuration.

5.4.6. NUMBER OF HELPERS

Each competitor is allowed only one mechanic/caller. The mechanic/caller must announce the start, finish and name or number of each manoeuvre, and should inform the pilot of wind direction, remaining flight time, proximity to prohibited areas and intrusions into the flight area. Team managers may observe the

flight from a position 5m behind the judges and away from the start circle. Team managers may serve as mechanic/caller if no separate person is available for this task.

5.4.7. NUMBER OF MODEL AIRCRAFT

The number of model aircraft eligible for entry is two (2). Model aircraft numbers 1 and 2 may only be exchanged within the start circle. Both model aircraft must use the same radio frequency.

5.4.8. NUMBER OF FLIGHTS

At Continental and World Championships, each competitor is entitled to four (4) official preliminary flights. After completion of the preliminary flights the top 15 are entitled to three fly-off flights. At national and open International Competitions the preliminary/fly-off system is not mandatory.

5.4.9. DEFINITION OF AN OFFICIAL FLIGHT

There is an official flight when the competitor is officially called. The flight may be repeated if, for any unforeseen reason outside the control of the competitor, the model aircraft fails to make a start such as:

- a) The flight cannot safely be made within the allowed time limit.
- b) The competitor can prove that the flight was hindered by outside interference.
- c) Judging was impossible for reasons beyond the control of the competitor (model aircraft, engine, or radio failures are not considered to be outside the control of the competitor). In such cases the flight **shall** be repeated as close to the published time as possible. The competitor, however, has the right to refuse a reflight.

5.4.10. SCORING

Each manoeuvre is given a score between 0 and 10 (including half) points by each judge. A new score sheet is issued to each competitor for each round. Only the competitor's number (no name or nationality) will appear on the score sheet. Any manoeuvre not completed shall be scored zero (0) points. If a manoeuvre is scored zero points all judges must agree. There shall be an official located on the field where any flight over the prohibited area can be observed. The prohibited area is the shaded area in Figure 5.4.A behind the judges' line. The area extends to infinity to the left, right and rear. A visual or audible signal shall be given to indicate such over flights. Competitors flying over this area will be penalised by scoring zero (0) points for the current flight. However, the judges shall score all manoeuvres. If an infringement has been made, the scores will be deleted from all score sheets after the flight. In addition, there shall be no score when:

- a) The competitor flies a model aircraft that has been flown in the same competition by another competitor, or flies a model aircraft that does not comply with the definition and general characteristics of a radio controlled helicopter.
- b) The competitor does not deliver his transmitter to the impound or operates any transmitter at the competition area during a round without permission.
- c) The competitor starts his model aircraft outside of the start circle.
- d) The competitor gets his transmitter from the impound before he is officially called.

5.4.11. CLASSIFICATION

After the completion of four official (preliminary) rounds, the best three scores will be used to determine the placings. The top 15 of all competitors then compete in three fly-off rounds to determine the final individual classification. The results of the best three preliminary rounds (normalised to 1000 points) will count as one score. This score, plus the three fly-off scores provide four scores with the best three to count for the final individual classification. The fly-offs to determine the individual classification are only required for World and Continental Championships.

If the competition is interrupted during the preliminary rounds, the final individual classification will be determined by counting all completed preliminary rounds and dropping the lowest. If the competition is interrupted during the fly-off rounds, the final individual classification will be determined by counting all completed fly-off rounds plus the results from the preliminary rounds and dropping the lowest.

All scores for each round will be normalised by awarding 1000 points to the highest scoring flight. The remaining scores are then normalised to a percentage of the 1000 points in the ratio of actual score over the score of the winner of the round. If only one round is possible then the classification will be based on that one round.

For example:

$Points_{(X)} = Score_{(X)}$ divided by $Score_{(W)}$ multiplied by 1000

Where $Points_{(X)}$ = Points awarded to competitor X

$Score_{(X)}$ = Score of competitor X

$Score_{(W)}$ = Score of winner of the round

Ties for any of the first three places will be broken by counting the highest throwaway score. If the tie still stands a "sudden death" fly-off must take place within one hour of the end of the scheduled fly-off rounds.

The team classification for World and Continental Championships is established at the end of the competition (after the fly-off flights) by adding the numerical final placing of the three team members of each nation. Teams are ranked from the lowest numerical scores to the highest, with complete three-competitor teams ahead of two-competitor teams, which in turn are ranked ahead of one-competitor teams. In case of a tie, the best individual placing decides the team ranking.

5.4.12. JUDGING

At Continental and World Championships the organiser must appoint a panel of five judges for each round/flight line. When the entry exceeds 55, two flight lines must be used. The judges must be of different nationalities and must be selected from the current CIAM list of international judges. When using two separate panels, the organiser is allowed to use two judges of the same nationality, one on each panel. Those selected must reflect the approximate geographical distribution of teams participating in the previous World Championship with the final list approval by the CIAM Bureau. For the preliminary rounds the final score of each flight is obtained by deleting the highest and lowest scores for each manoeuvre from the five judges. For the fly-off rounds ten judges shall be used while dropping the two lowest and two highest scores for each manoeuvre. At open or other International Competitions the number of judges may be reduced to a minimum of three with no throwaway scores.

- a) There shall be training flights for judges with a debriefing session immediately before a Continental or World Championships.
- b) The scoring system must be organised in such a way that the competitors and the spectators can clearly see the scores awarded by all judges after each flight. The score sheet notation must be written by the judges themselves.

5.4.13. ORGANISATION

TRANSMITTER & FREQUENCY CONTROL (See VOLUME ABR, Section 4B, Paragraph B.11.2). When all transmitters are of the spread spectrum type a transmitter impound is not required.

FLIGHT ORDER

The flight order for the first preliminary round will be determined by a random draw, taking into account that frequency will not follow frequency and team member will not follow team member of the same team. The flight order for preliminary rounds two, three and four will start at the first, second and third quarter of the initial order. The flight order for the first fly-off round will be established by a random draw. The flight order for the second and third fly-off rounds will start at the first and second third of the initial order.

PREPARATION TIME

A competitor must be called at least 5 minutes before he is required to enter the start circle. A start circle 2m in diameter will be provided away from the flight line, spectators, competitors and model aircraft (see FIGURE 5.4.A). When the previous competitor's flight time reaches 6 minutes the flight line director can give the signal to start the engine. The competitor is given 5 minutes to start the engine and make last minute adjustments. The model aircraft may only be hovered in the start circle up to 2m and must not be rotated beyond 180° left or right relative to the competitor. If the model aircraft is rotated beyond 180° the flight is terminated. The competitor in the start circle must reduce his engine's speed to an idle when the preceding competitor has completed the eighth manoeuvre. If the competitor is not ready after the 5 minute preparation time, he is allowed to complete his adjustments in the start circle; however, his flight time will have started at the end of the 5 minute interval.

FLIGHT TIME

The flight time of 10 minutes begins when the competitor's model leaves the start circle with the permission of the flight line director and the judges. If the allotted time expires before a manoeuvre is completed, that manoeuvre and all remaining manoeuvre(s) will be scored zero.

RESTRICTIONS

After starting the model aircraft in the start circle the model aircraft must be flown at 2m to the helipad along the model entry path shown on the Contest Area Layout (Figure 5.4.A). The pilot may test hover the helicopter on the helipad and reposition it, before announcing the start of the first manoeuvre, to accommodate wind conditions. If the engine stops the flight is terminated.

INTERRUPTION OF A COMPETITION

If the wind component perpendicular to the flight line exceeds 8ms/s for a minimum of 20 seconds during a flight, the competition must be interrupted. The flight will be repeated and the competition continued as soon as the wind subsides below the criterion. If the wind does not subside before the round is completed, the entire round will be dropped. The determination will be made by the organiser with concurrence of the FAI Jury.

5.4.14. MANOEUVRE SCHEDULES

FLIGHT PROGRAM

The flight program consists of manoeuvre schedules P and F for the years 2010 - 2013. Each schedule consists of ten (10) manoeuvres (see ANNEX 5D - F3C MANOEUVRE DESCRIPTIONS).

PERFORMANCE OF THE SCHEDULES

The competitor must stand in the 2m circle (labelled P in Figure 5.4.A - F3C Contest Area Layout) located 6m in front of the centre judge. Before the start of the first manoeuvre the competitor must fly the model aircraft at 2m altitude to the 1m circle of the helipad. The model aircraft may face left or right but must be parallel with the judges' line. Each hovering manoeuvre ends with a landing on the helipad and after each landing the model aircraft may be repositioned (but maintains same direction) prior to the next takeoff. After completing the hovering manoeuvres the competitor is allowed one free pass to set up for the flying sequence. All aerobatics manoeuvres must be performed in an airspace that will allow them to be clearly seen by the judges. This airspace is defined by a field of view up to 60° above the horizon and between lines 60° to the right and left of judges 1 and 5. The non-observance of this rule will be penalised by a loss of points. The aerobatics manoeuvres must be performed in a smooth flowing sequence, with a manoeuvre performed on each pass before the judges. There are no restrictions on turnaround manoeuvres. The competitor must perform each listed manoeuvre only once during a flight. The competitor or his caller must announce the name (number) and start and finish of each manoeuvre. A manoeuvre performed out of sequence will result in a zero score for that manoeuvre only. Before the autorotation manoeuvre the competitor is allowed another free pass to accommodate a possible change in wind direction.

5.4.15. MANOEUVRE DESCRIPTIONS AND DIAGRAMS

Refer to ANNEX 5D

5.4.16. JUDGES' GUIDE

Refer to ANNEX 5E

FIGURE 5.4.A - F3C CONTEST AREA LAYOUT

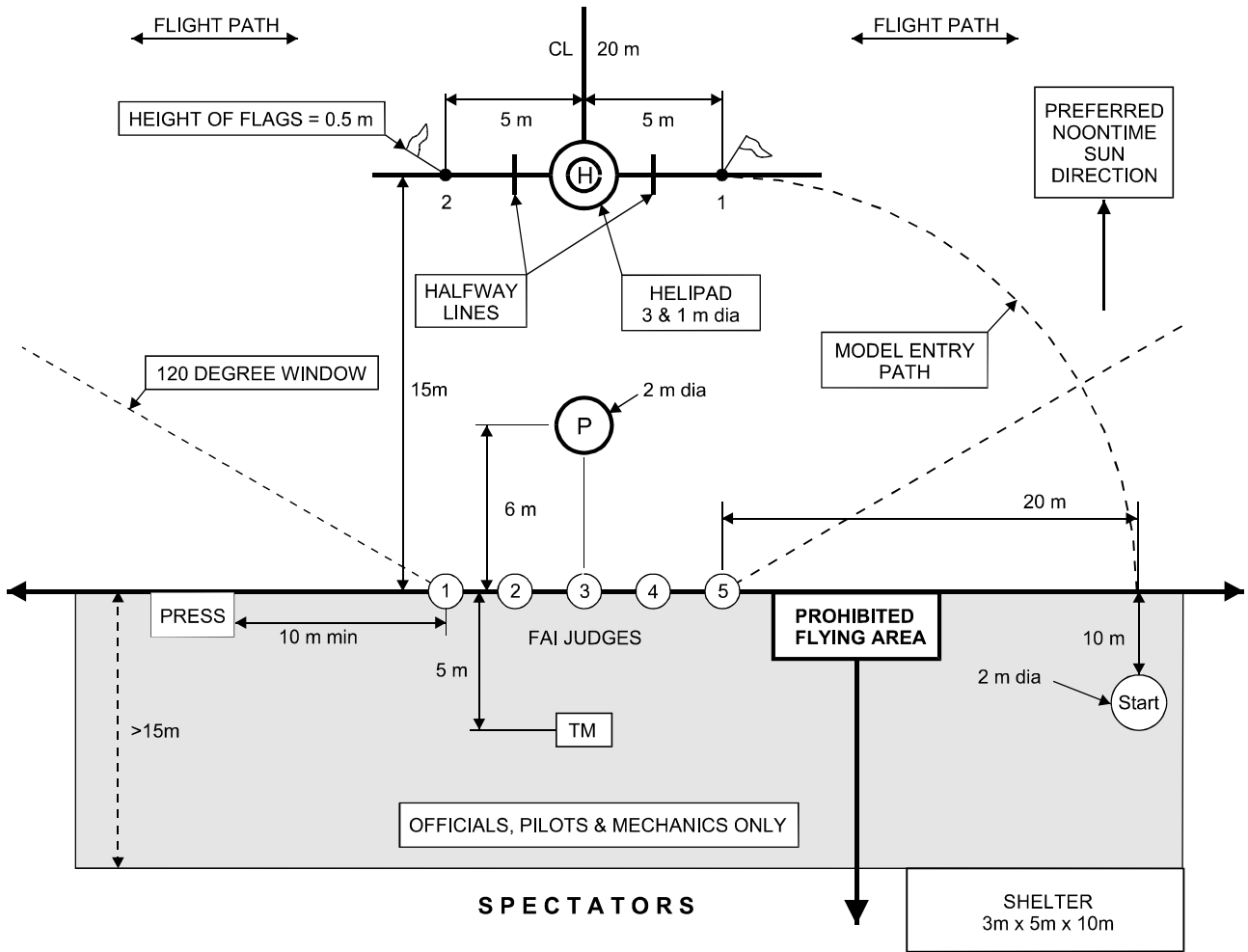

ANNEX 5D

F3C MANOEUVRE DESCRIPTIONS AND DIAGRAMS

The manoeuvre schedules are listed below with the starting and ending direction (UU = Upwind - Upwind; DD = Downwind - Downwind; DU = Downwind - Upwind; UD = Upwind - Downwind) of each manoeuvre, relative to the wind, as indicated. The competitor has 10 minutes to complete each schedule. Schedule P will be flown for the preliminary rounds 1 through 4. Schedule F will be flown for the Fly-Off rounds.

SCHEDULE P

P1. FIGURE "M" WITH HALF PIROUETTES	(UU)
P2. SEMI CIRCLE WITH PIROUETTE	(UU)
P3. DIAMOND 3	(UU)
(FLY BY)	
P4. CUBAN 8 WITH HALF 4 POINT ROLLS	(DD)
P5. PULLBACK WITH BACKWARD ROLL.....	(UU)
P6. COBRA ROLL WITH $\frac{3}{4}$ PUSHED FLIP	(DD)
P7. CANDLE WITH TWO HALF ROLLS, HALF PUSHED FLIP.....	(UU)
P8. TWO OPPOSITE TWO POINT ROLLS.....	(DD)
P9. INSIDE LOOP WITH PIROUETTE	(UU)
(FLY BY)	
P10. AUTOROTATION WITH TWO 90° TURNS.....	(DU)

SCHEDULE F

F1. CIRCLE WITH 360° PIROUETTE.....	(UU)
F2. INVERTED TRIANGLE 2.....	(UU)
F3. OVAL 1.....	(UU)
(FLY BY)	
F4. CUBAN 8 WITH PUSHED FLIP.....	(DD)
F5. PULLBACK WITH 3 HALF LOOPS AND 2 TAIL TURNS.....	(UU)
F6. COBRA ROLL WITH PIROUETTE	(DD)
F7. TWO LOOPS WITH HALF ROLLS	(UU)
F8. PUSHED FLIP WITH HALF ROLLS	(DD)
F9. VERTICAL 540° FLIP.....	(UD)
(FLY BY)	
F10. "S" AUTOROTATION	(UU)

5D.1 GENERAL

The manoeuvres are displayed in pictorial form in Figures 5D-P and 5D-F for the case where the wind direction is left to right. The following descriptions apply to all manoeuvres and if not performed properly must result in downgrades. Points will also be subtracted if a manoeuvre is not performed as described. The starting/ending altitude for the hovering manoeuvres is 2m above the helipad. If a manoeuvre is unrecognisable it must be severely downgraded. If pirouettes are performed in the wrong direction, the score shall be zero (0) points. Ascents from, and descents to, the helipad must be vertical. Landings must be smooth and centred on the helipad. During the hovering manoeuvres all stops must be of 2 seconds minimum duration (unless specified otherwise). Circular and linear hovering segments must be performed at a constant speed. Every pirouette must be performed at a constant turning rate. The hovering manoeuvres must be started with the nose of the model aircraft (MA) facing left or right and must be flown as a unit (the starting heading must be same for each hovering manoeuvre). The competitor must stand in the 2m diameter circle marked "P" in Figure 5.4.A during all manoeuvres. All aerobatic manoeuvres must start and end in the direction indicated with a straight and level flight line of 10m minimum length. Entry and exit must be at the same altitude and heading. Loops or parts of a loop must be round and have the same diameter. Consecutive loops must be in the same location and plane. Rolls must be performed at a constant roll rate. Consecutive rolls must have the same roll rate and must be at the same altitude and heading. During all aerobatics manoeuvres the competitor must maintain his MA above a minimum altitude of 10 m. Aerobatic manoeuvres must be centred within the 120° horizontal field of view and must be symmetrical about the centre line. Aerobatic manoeuvres flown at a distance greater than 100m from the judges' line will be downgraded. In case of a dispute the following text takes precedence over Figures 5D-P-and 5D-F.

5D.2 SCHEDULE P

P1. FIGURE "M" WITH HALF PIROUETTES – (UU)

The MA lifts off from the helipad and hovers at 2m. MA backs up, stops and hovers over flag 1(2). MA ascends 2.5m while performing a 180° pirouette and stops for 1 second, continues ascent while performing a 180° pirouette and stops at 5m. MA descends 2.5m at 45° while performing a 180° pirouette and stops for 1 second. MA continues 45° descent while performing a 180° pirouette and stops at 2m. MA ascends 2.5m at 45° while performing a 180° pirouette and stops for 1 second, continues ascent while performing a 180° pirouette and stops at 5m. MA descends 2.5m while performing a 180° pirouette and stops for 1 second, continues descent while performing a 180° pirouette and stops at 2m over flag 2(1). MA backs up 5m, stops and hovers over helipad. MA descends and lands on helipad.

P2. SEMI CIRCLE WITH PIROUETTE – (UU)

MA takes off vertically to 2m and stops. MA flies backward to flag 1(2) and stops. MA then performs a semi circle with 5m radius with a simultaneous full pirouette in either direction to 2m above flag 2(1) and stops. MA hovers backward to helipad and stops. MA descends to helipad and lands.

P3. DIAMOND 3 – (UU)

MA ascends vertically to 2m and stops. MA ascends backwards 2.5m in a straight line while simultaneously performing a 90° pirouette (nose to the pilot) and stops over flag 1(2). MA ascends sideways 2.5m in a straight line and stops over helipad. MA performs a 360° pirouette in either direction and stops. MA descends sideways 2.5m in a straight line and stops over flag 2(1). MA descends 2.5m in a straight line while simultaneously performing a 90° pirouette in opposite direction to the first one and stops at 2m over helipad. MA descends to helipad and lands.

P4. CUBAN 8 WITH HALF 4 POINT ROLLS – (DD)

MA flies straight and level for a minimum of 10m and performs a 5/8 inside loop. When MA is in 45° descent and inverted it performs a half 4 point roll (180° roll with hesitation at 90°) in either direction to upright and enters a ¾ inside loop. When the MA is again in 45° descent and inverted it performs a second half 4 point roll (180° roll with hesitation at 90°) in either direction and finishes the first partial loop in upright attitude. MA flies 10m straight and level exit.

P5. PULLBACK WITH BACKWARD ROLL – (UU)

MA flies straight and level for 10m and enters the manoeuvre by pulling up into a vertical ascent after passing the centre line. After MA comes to a stop the MA accelerates with a 90° pushed travelling flip to backward flight and performs a full backward roll at constant altitude. This is followed by another 90° pushed travelling flip to a vertical nose down stop. MA then continues by descending on a path that mirrors the entry path. After the descent, MA transitions to same heading and altitude as at the start of the manoeuvre. MA continues for 10m to finish the manoeuvre.

P6. COBRA ROLL WITH ¾ PUSHED FLIP – (DD)

MA flies straight and level for 10m and enters the manoeuvre by pulling up into a 45° climb. After a 5m minimum straight segment MA performs a half roll in either direction to the inverted position and continues to climb at 45° for 5m minimum. After MA comes to a stop MA makes a 270° pushed stationary flip before it enters a 45° dive and after a 5m minimum straight segment performs another half roll in either direction. MA continues for 5m minimum and then recovers at starting altitude in level flight for 10m to finish manoeuvre.

P7. CANDLE WITH TWO HALF ROLLS, HALF PUSHED FLIP – (UU)

MA flies straight and level for 10m and enters the manoeuvre by pulling up into a 5m (minimum) vertical ascent, followed by half roll and another 5m (minimum) ascent. MA performs a half pushed travelling flip such that the first half occurs during the ascent and the second half occurs during the descent. MA goes into a vertical 5m descent followed by a half roll and another 5m descent to same altitude as entry. MA continues for 10m to finish the manoeuvre.

Note : MA must be horizontal at the top.

P8. TWO OPPOSITE TWO POINT ROLLS – (DD)

MA flies straight and level for a minimum of 10m and performs a 180° roll and continues with 1 second inverted flight. MA performs a second 180° roll in same direction followed by 1 second upright flight. MA performs third 180° roll in opposite direction of first two and continues with 1 second inverted flight. MA performs fourth 180° roll in same direction as third 180° roll to upright flight. Manoeuvre is completed with 10m straight and level flight.

P9. INSIDE LOOP WITH PIROUETTE – (UU)

MA flies straight and level for 10m minimum entry. MA performs an inside loop with a travelling 360° pirouette on top with minimum duration of 2 seconds. Manoeuvre is completed with 10m straight and level flight.

P10. AUTOROTATION WITH TWO 90° TURNS – (DU)

MA flies at a minimum altitude of 20 m. Manoeuvre begins when MA crosses an imaginary plane that extends vertically upward from a line drawn from the centre judge out through the helipad. MA must be in the autorotation state when it cuts this plane. The engine power must be reduced to idle (or off) at this point and the MA must be descending. The first 90° turn must be made after the MA has made 1/3 of the total descent. After this turn the MA must fly straight before the next turn is made after the MA has made 2/3 of the descent. The MA then flies straight down to the helipad. Each leg of the manoeuvre must be a minimum of 10m in length. The descent rate must be constant from start to a point just before touchdown on the helipad. The flight path of the MA must appear as an open square when viewed from above, starting at the vertical plane and ending at a line drawn from the centre judge through the helipad.

Scoring criteria for landing: See ANNEX 5E Paragraph 5E.6.10.

5D.3 SCHEDULE F

F1. CIRCLE WITH 360° PIROUETTE – (UU)

MA takes off vertically from the helipad and ascends to 2m and stops. MA starts backwards into a 5m vertical circle while simultaneously performing a 360° pirouette. At the end of the vertical circle MA comes to a stop at 2m over helipad. MA then descends to a landing on the helipad.

F2. INVERTED TRIANGLE 2– (UU)

MA takes off vertically from helipad and stops at 2m. MA performs a 90° pirouette so nose points to the pilot. MA ascends at 45° while performing 180° pirouette and stops over flag 1(2). MA then flies horizontally to flag 2(1) while performing a 4 point pirouette and stops. (The stops between the points of 4-point pirouette are of 1 second duration.) MA descends at 45° while performing 180° pirouette and stops at 2m over helipad. Model then performs a 90° pirouette and stops. MA then descends to and lands on helipad.

F3. OVAL 1- (UU)

MA takes off vertically from helipad to 2m and stops. MA moves 2.5m backwards while performing 90° pirouette and continues into a half ascending vertical circle of 5m diameter while simultaneously performing a 180° pirouette. MA hovers sideways from one halfway line to the other with nose facing the pilot. MA continues into a half descending vertical circle while simultaneously performing a 180° pirouette in opposite direction to the first to the second half way line and then continues back while performing a 90° pirouette to 2m over helipad and stops. MA descends to a landing on the helipad. (There are no stops during this manoeuvre except the two over the helipad).

F4. CUBAN 8 WITH PUSHED FLIP – (DD)

MA flies straight and level for a minimum of 10m and performs a 5/8 inside loop. When the MA is in first 45° descent and inverted it performs a full pushed travelling flip. MA continues with a ¾ outside loop. When MA is in second 45° descent it finishes the first partial loop in upright attitude. MA flies straight and level for a minimum of 10 m.

F5. PULLBACK WITH THREE HALF LOOPS AND TWO TAIL TURNS - (UU)

MA flies straight and level for a minimum of 10m. MA enters vertical ascent and stops and performs a small backward half inside loop followed by a 180° tail turn. MA performs a small backward half outside loop followed by a 180° tail turn. MA performs a small backward half inside loop and stops. MA then descends vertically to same altitude as entry and finishes by flying straight and level for 10m.

F6. COBRA ROLL WITH PIROUETTE – (DD)

MA flies straight and level for a minimum of 10 m. MA pulls up to establish a 45° line. MA then performs a 180° roll to inverted and continues to the apex. At apex MA performs a 135° pushed stationary flip followed by a slow (4 seconds minimum) 360° piroquette followed by a second 135° pushed stationary flip. MA then enters a 45° descent with a centred 180° roll back to the same altitude as at entry. MA finishes manoeuvre with straight and level flight of 10m minimum.

F7. TWO LOOPS WITH HALF ROLLS – (UU)

MA flies straight and level for a minimum of 10m. MA flies a half loop with a half roll on top, continues with a full outside loop followed by a half roll and half inside loop. The two half rolls must be included in the loop paths. (The two half rolls must be included in the loop paths such that MA is in knife edge flight at the top of the loops). MA finishes manoeuvre with a straight and level flight of 10m minimum.

F8. PUSHED FLIP WITH HALF ROLLS – (DD)

MA flies straight and level for a minimum of 10m. MA performs a 180° roll to 1 second duration inverted flight. MA then performs a travelling, full pushed flip followed by 1 second inverted flight. MA then performs a second 180° roll to upright and finishes the manoeuvre with 10m straight and level flight.

F9. VERTICAL 540° FLIP – (UD)

MA flies straight and level for a minimum of 10m. MA then enters a centred vertical climb and performs a 540° pushed travelling flip. Half (270°) of the pushed travelling flip is performed during the ascent and the second half is performed during the descent. MA must be horizontal and inverted at the top. MA then descends vertically 5m (minimum), performs a 180° roll followed by another 5m (minimum), 90° inside loop back to entry altitude and opposite heading. MA finishes manoeuvre with 10m minimum straight and level flight.

F10. "S" AUTOROTATION– (UDU)

MA enters the manoeuvre going upwind at a minimum altitude of 40m and some distance out. Before crossing the centre plane upwind the MA must be in the auto rotation state, the engine power must be reduced to idle (or off) at this point and the MA must be descending. MA then makes the first 180° turn towards the pilot. As MA crosses the centre plane again but downwind it enters another descending 180° turn toward the pilot and lands upwind.

Scoring criteria for landing: See ANNEX 5E Paragraph 5E.6.10.

Note: Manoeuvre diagrams are overleaf.

1. FIGURE "M" WITH HALF PIRQUETTES

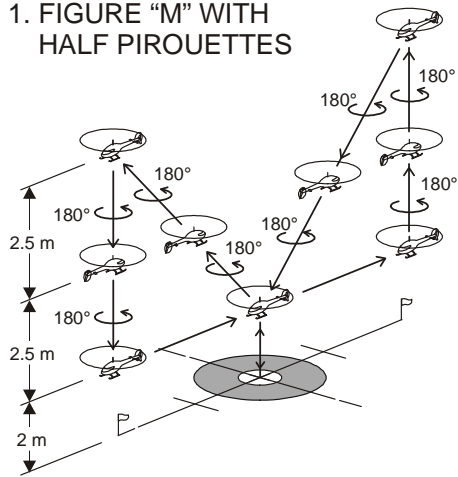

2. SEMI CIRCLE WITH PIRQUETTE

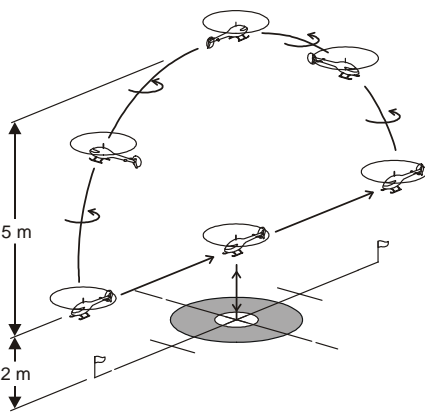

3. DIAMOND 3

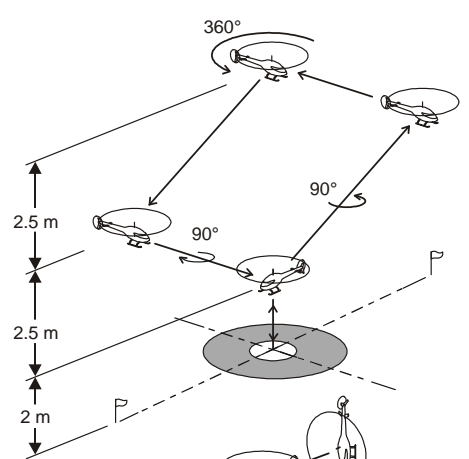

4. CUBAN EIGHT WITH HALF 4 POINT ROLLS

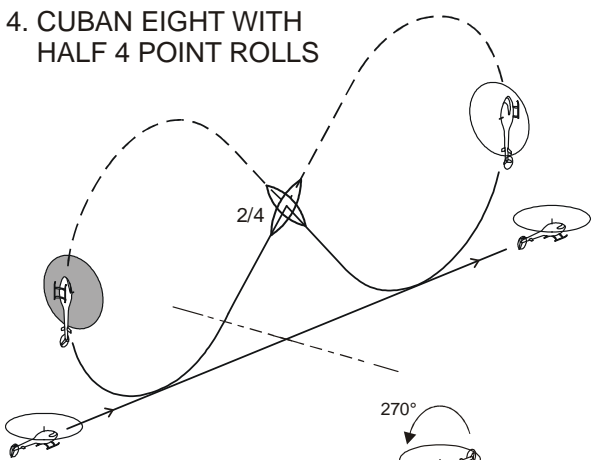

5. PULLBACK WITH BACKWARD ROLL

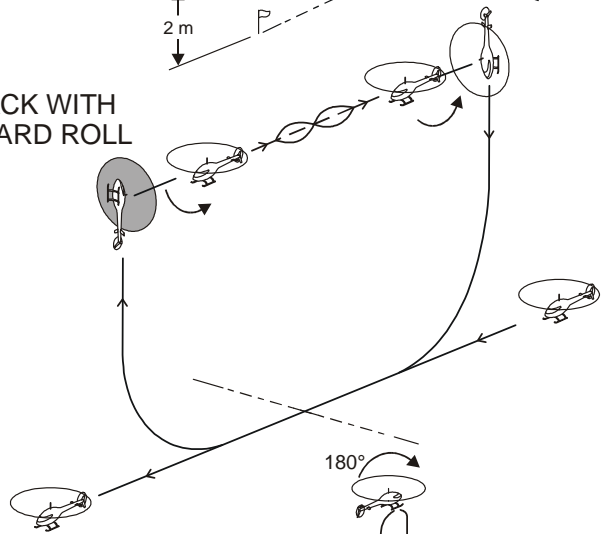

6. COBRA ROLL WITH PUSHED FLIP

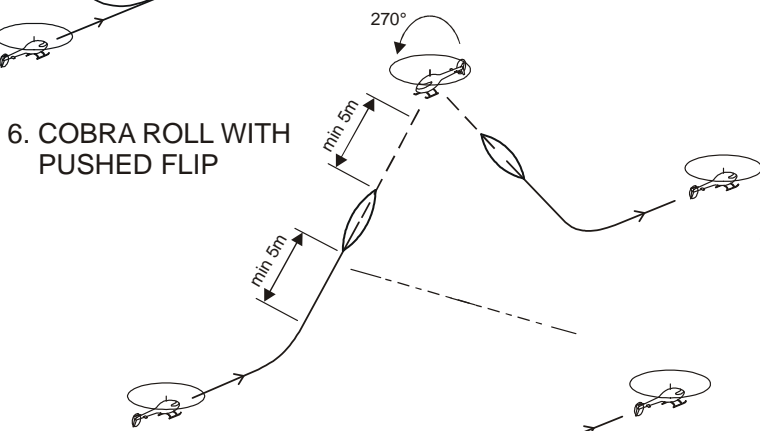

7. CANDLE WITH HALF ROLLS AND HALF PUSHED FLIP

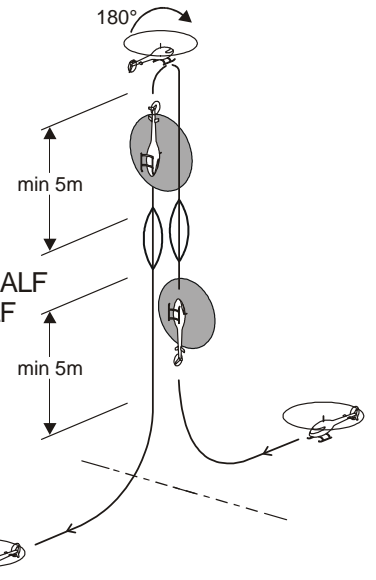

8. TWO OPPOSITE 2 POINT ROLLS

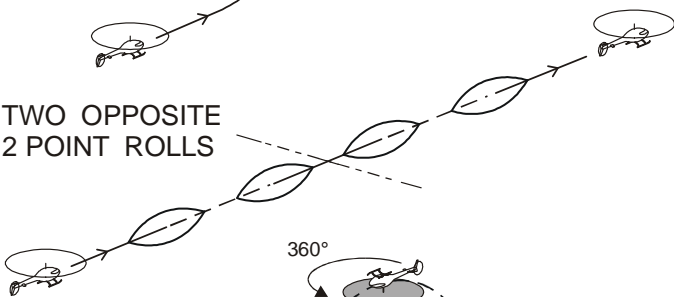

9. INSIDE LOOP WITH PIRQUETTE

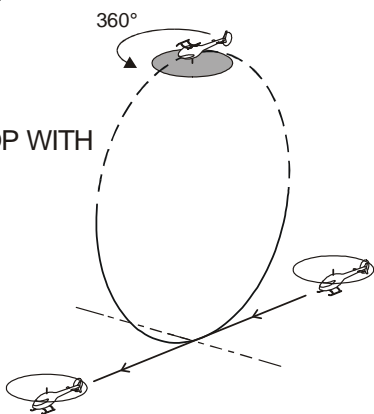

10. AUTOROTATION WITH TWO 90° TURNS

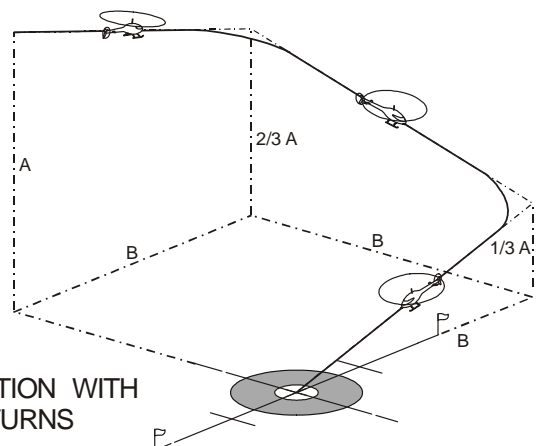

1. CIRCLE WITH 360°
PIROUETTE

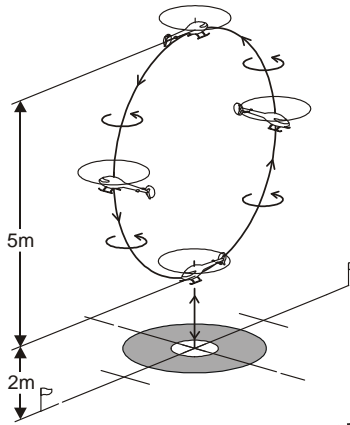

2. INVERTED TRIANGLE 2

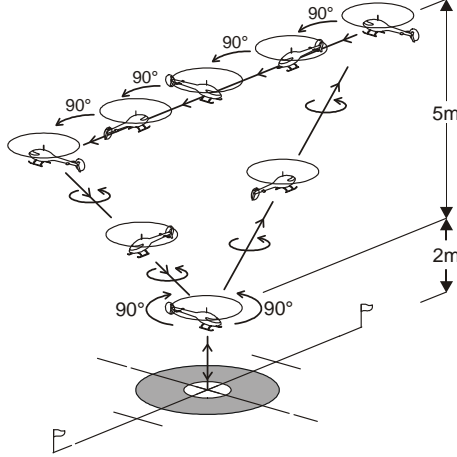

3. OVAL 1

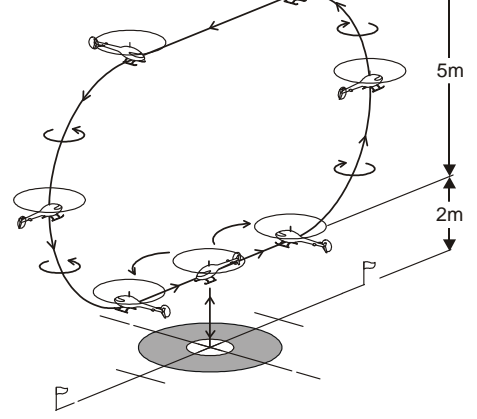

4. CUBAN EIGHT WITH
PUSHED FLIP

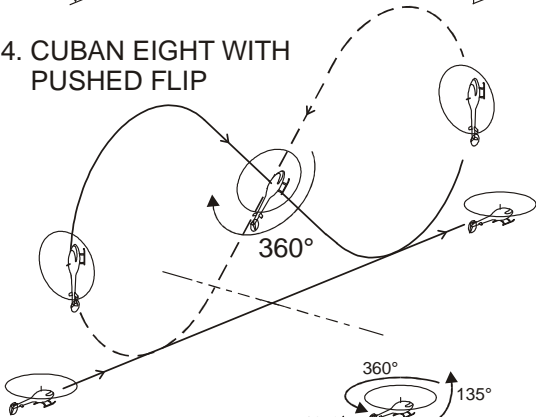

5. PULLBACK WITH 3 HALF LOOPS
AND TWO TAIL TURNS

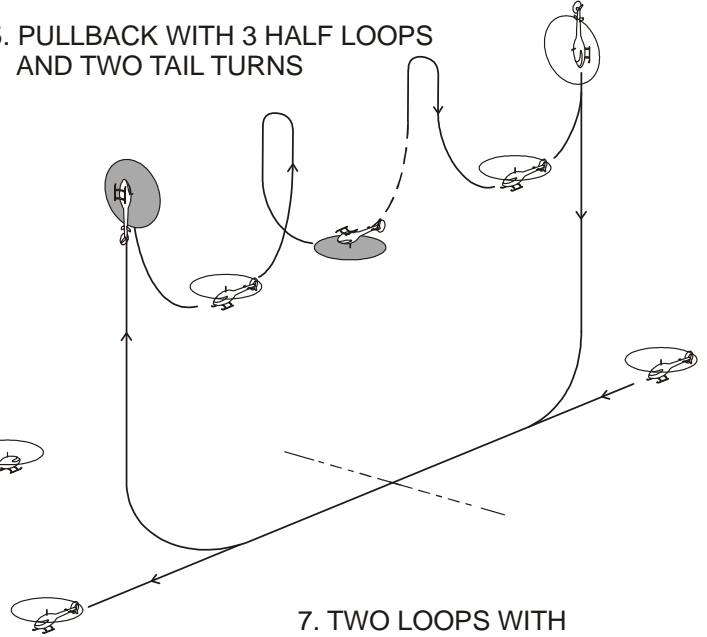

6. COBRA ROLL WITH
PIROUETTE

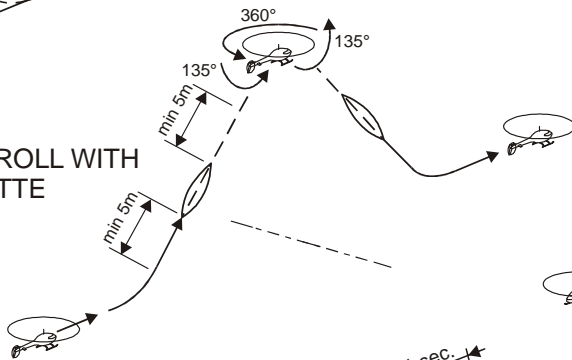

7. TWO LOOPS WITH
HALF ROLLS

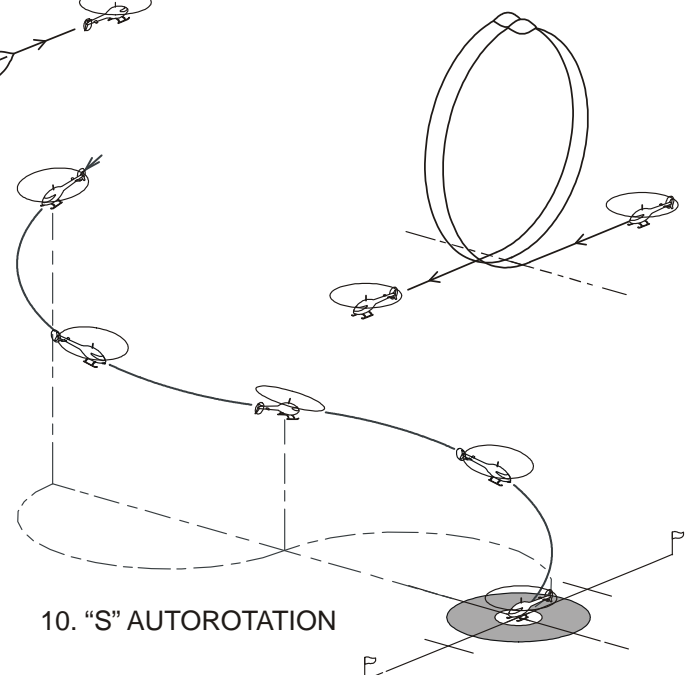

8. PUSHED FLIP WITH
HALF ROLLS

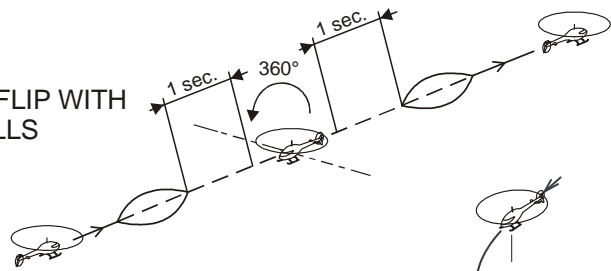

9. VERTICAL 540° FLIP

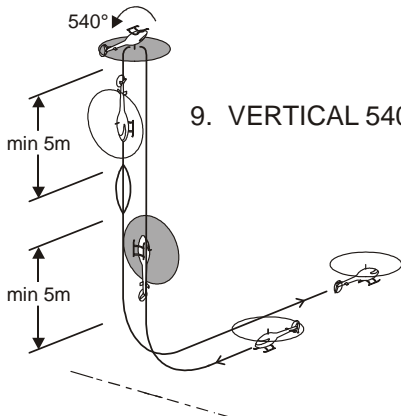

10. "S" AUTOROTATION

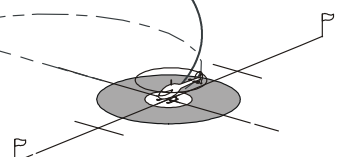

ANNEX 5E

F3C JUDGES' GUIDE

5E.1 PURPOSE

The purpose of the F3C Judges' Guide is to provide an accurate description of the major judging criteria to serve as a reference for use in developing a uniformly high standard of judging.

5E.2 PRINCIPLES

The principles of judging a radio controlled model helicopter should be based on the perfection with which the MA performs each manoeuvre as described in Annex 5D.

The main principles used to judge the degree of perfection are:

- 1) Precision of the manoeuvre.
- 2) Smoothness and gracefulness of the manoeuvre.
- 3) Positioning or display of the manoeuvre.
- 4) Size of the manoeuvres relative to each other.

The requirements are listed in order of importance; however, all of them must be met for a manoeuvre to receive a high score.

5E.3 ACCURATE AND CONSISTENT JUDGING

The most important aspect of judging is consistency. Each judge must establish his standard and then maintain that standard throughout the competition. It is recommended that the contest director or organiser hold a conference prior to the start of competition to discuss judging so that the standards are as uniform as possible. This can be accomplished with demonstration flights that all judges score simultaneously and privately. After these flights, the defects in each manoeuvre should be discussed by all judges and agreement reached about the severity of the defects. After the competition is started, the individual judges should not alter their standard. Judging accuracy is also very important. Being consistent, whether high or low is not sufficient if the scores awarded do not fairly reflect the performed manoeuvre.

5E.4 CRITERIA FOR JUDGING MANOEUVRES

A description of each manoeuvre is provided in Annex 5D. Each manoeuvre should be downgraded according to:

- 1) The type of defect.
- 2) The severity of the defect.
- 3) The number of times a defect occurs.
- 4) The positioning of the manoeuvre.
- 5) The size of the manoeuvre relative to other manoeuvres.

A high score should be given only if no major defects are noted and the manoeuvre is accurately positioned. Whenever there is doubt a lower score should be given.

5E.5 ATTITUDE AND FLIGHT PATH

The flight path of the MA is the trajectory of its centre of gravity. The attitude is the direction of the fuselage (canopy, boom, etc.) centreline in relation to the flight path. All judging should be based on flight path, but the angle between the flight path and the longitudinal axis should never exceed 10°.

5E.6 GRADING CRITERIA FOR MANOEUVRE SEGMENTS

The following criteria are furnished to provide the judge with a guide for downgrading deviations from the defined manoeuvre segments. The segments are: Takeoffs, Landings, Stops, Lines, Pirouettes, Loops, Rolls, Stall turns and Flips.

5E.6.1. TAKEOFFS

Takeoffs for the hovering manoeuvres must start from the centre of the 1m circle to obtain maximum score. Takeoffs must be smooth and the MA must ascend vertically until the skids or landing gear are at 2m over helipad. Non-vertical ascents where the MA moves forward or backward by half a fuselage length result in a downgrade of 1 point.

5E.6.2. LANDINGS

Landings for the hovering manoeuvres must be centred in the 1m circle of the helipad to obtain a maximum score. If a portion of the skids or landing gear is outside of the 1m circle (but rotor shaft points to the inside of the 1m circle when viewed from above), the downgrade is one point. A landing outside of the 1m circle (rotor shaft points to the outside of the 1m circle when viewed from above) results in a downgrade of 2 points. Non-vertical descents where the MA moves forward or backward by half a fuselage length result in a downgrade of 1 point.

5E.6.3. STOPS

For the hovering manoeuvres the stops must be equal to or greater than 2 seconds in duration if not otherwise specified. All stops must be of the same duration. If a stop is less than 2 seconds long, a downgrade of half a point should be made. If a stop is greater than 2 seconds, no downgrade should result as long as the MA does not move.

5E.6.4. LINES

For the hovering manoeuvres the lengths of the lines are defined by the 10m distance between flags 1 and 2 and must be straight. Diagonal lines must be performed at the proper angle. However, the aerobatic manoeuvres must be started and ended by equal horizontal lines of minimum length 10 m. A greater length of a vertical or climbing line, resulting from the performance of the MA, must not be allowed to positively influence a judge's score. One point should be subtracted for a recognisable difference. If there is a complete absence of a line, before or after a manoeuvre, 2 points should be subtracted.

5E.6.5. PIROUETTES

All pirouettes must be performed around the vertical axis. If the deviation is greater than 20° one point will be subtracted. During a hovering pirouette (stationary tail rotor turn), if the MA moves vertically or laterally by a noticeable amount, 1 point should be subtracted. If the vertical or lateral movement of the helicopter is significant (more than 25cm), 2 or more points should be subtracted. During an ascending pirouette, if the MA moves laterally by a noticeable amount, 1 point should be subtracted. If the MA's movement is greater than 25cm, 2 or more points should be subtracted. Travelling pirouettes must be synchronised with flight path. If the pirouettes are performed in the same direction for manoeuvres where pirouettes of opposite direction are prescribed, the score must be zero.

5E.6.6. LOOPS

A loop must, by definition, have a constant radius, and must be flown in a vertical plane. It starts and ends with a well-defined line, which for a complete loop will be horizontal. Every loop must be flown without segmentation. Every clearly seen segment should result in a downgrade of 1 point. If a loop is not flown entirely in a vertical plane, a minor drift should be downgraded by 1 point, while a more severe drift should be downgraded by several points.

5E.6.7. ROLLS

The roll rate must be constant. Small variations in roll rate should be downgraded by 1 point while more severe variations receive larger downgrades. Rolls (including partial rolls) must have crisp and well-defined starts and stops. If a start or stop is badly defined, 1 point is subtracted for each. Duration of the rolls must meet the minimum times specified.

5E.6.8. TAIL TURNS

The tail turns must be symmetrical by performing half of the rotation before and after the top. The tail turn must be around the main rotor shaft. If there is significant horizontal displacement, 1 point should be subtracted. The entry and exit must consist of partial loops with constant and equal radii.

5E.6.9. FLIPS

Flips are stationary or travelling rotations about the lateral (elevator) axis of the MA. The direction of the flip is described according to the movement of the (elevator/longitudinal cyclic) control stick (Push = Negative - Nose down, Pull = Positive - Nose up). For the case of a stationary flip, one point should be subtracted if the MA moves forward or backward more than a fuselage length. For the case of a travelling flip, one point should be subtracted for a deviation of more than a fuselage length from the path of the described manoeuvre.

5E.6.10. AUTOROTATIONS

An autorotation begins when MA crosses an imaginary plane that extends vertically upward from a line drawn from the centre judge out through the centre of the 1m helipad. MA must be in the autorotation state when it cuts this plane, the engine power must be reduced to idle (or off) at this point and the MA must be descending. During the manoeuvre, the forward speed and rate of descent should be constant, which means that the angle of the flight path is also constant. After landing the MA must be parallel to the judges' line. If the flight path is stretched, shortened or deviated from, to reach a circle the manoeuvre must be downgraded. The original flight path gives a basic maximum score according to the description and there will be additional downgrades of 1 or 2 points depending of the severity of the deviation. For example: If the flight path clearly points to a landing close to flag 1 (2) and the path is stretched to reach a circle, the score can only be a maximum of 6 (outside the circles) and there will be an additional downgrade of 2 points for the stretch, so the score can only be a maximum of 4. If the pilot would have landed without stretching, the maximum score would have been a 6. Therefore, stretching the flight path must never lead to a higher score.

Scoring criteria for Autorotation landings:

Landing gear inside 1m circle = Maximum 10 points.

Rotor shaft points to inside of 1m circle = Maximum 9 points.

Landing gear inside 3m circle = Maximum 8 points.

Rotor shaft points to inside of 3m circle = Maximum 7 points.

Rotor shaft points to outside of 3m circle = Maximum 6 points.

5E.7 WIND CORRECTION

All manoeuvres are required to be wind corrected in such a way that the shape of the manoeuvre as described in Annex 5D is preserved in the MA's flight path.

5E.8 POSITIONING

All aerobatic manoeuvres must be performed within the 60° vertical and 120° horizontal viewing angle. Manoeuvres that are flown off centre will be downgraded according to the displacement. The downgrade may be in the range of 1 to 4 points. If a portion of a manoeuvre is flown outside of this air space a severe downgrade will occur. If the entire manoeuvre including entry and exit is flown outside of the window it must be scored zero points. Flying so far out as to make the evaluation of a manoeuvre difficult should also be severely downgraded. The main criterion here is visibility. Manoeuvres performed on a line further out than 100m away but in front of the judges should be downgraded in any case because even the keenest eye begins to lose perspective at that distance.

ANNEX 5F

CLASS F3N – RADIO CONTROLLED HELICOPTER FREESTYLE

5F.1 DEFINITION OF A RADIO CONTROLLED MODEL HELICOPTER

A Radio Controlled (R/C) model helicopter is a heavier-than-air Model Aircraft (MA) that derives all of its lift and horizontal propulsion from a power driven rotor system(s) rotating about a nominally vertical axis (or axes). Fixed horizontal supporting surfaces up to 4 percent of the swept area of the lifting rotor(s) are permitted. A fixed or controllable horizontal stabiliser of up to 2% of the swept area of the lifting rotor(s) is permitted. Ground effect machines (hovercraft), convertiplanes or aircraft that hover by means of propeller slipstream(s) deflected downward are not considered to be helicopters.

5F.2 GENERAL CHARACTERISTICS

The swept area of the lifting rotor is not limited. The engine displacement is not limited. The use of pre-programmed flight manoeuvres is forbidden.

Limitations are:

- a) WEIGHT: The weight of the MA (with fuel or with batteries) must not exceed 6,5 kg.
- b) BATTERIES: Electric motors are limited to a maximum no load voltage of 51 volts for the propulsion circuit.
- c) ROTOR BLADES: All-metal main or tail rotor blades are prohibited.

5F.3 CONTEST AREA LAYOUT

Refer to Figure 5F.A. The drawing shows a recommended layout, but the distances should be kept for safety reasons.

5F.4 NUMBER OF HELPERS

After leaving the start box, the pilot is allowed on helper. The helper may give information to the pilot during the flight.

5F.5 NUMBER OF MODEL AIRCRAFT

The number of MA is not limited. One MA may be used by several pilots.

5F.6 THE OFFICIAL FLIGHT

Before the flight the pilot has to be officially called. The MA can be flown or be carried to the flying area. The flight begins in the compulsory schedule when the MA leaves the start box; in freestyle with the announcement of the start. In the compulsory schedule the pilot is allowed to restart his engine once only after an autorotation.

5F.7 SCORING

The number of judges is at least three, max five. In the Freestyle Compulsory program each manoeuvre is given a score between 0 and 20 points by each judge. A manoeuvre not completed or not flown according to the description shall be scored zero (0) points. If a manoeuvre is scored zero points all judges must agree. In the Freestyle Unlimited Program the scoring is made after the flight according to the scoring criteria.

In the Freestyle Compulsory program only manoeuvres that are performed completely in the flight time of 8 minutes will receive a score. If the flight time for the Freestyle Unlimited or Music program is less than three or more than five minutes, there will be a downgrade of 5% for the flight.

The prohibited flying area is observed by the judges. If the safety line is crossed the flight will be scored zero points.

5F.8 CLASSIFICATION

After the completion of every round, all scores will be normalised by awarding 1000 points to the highest scoring flight. The remaining scores are then normalised to a percentage in the ratio of actual score over the highest score of the round.

There shall be two rounds for the compulsory schedule and one round each for freestyle unlimited and music freestyle. However, the lowest score of each competitor will be the throwaway score, the other scores are added and then divided by the number of counting preliminary rounds. The result is the preliminary score. If only one round is possible then the classification will be based on that round. After completion of the preliminary flights the top 10 are entitled to two fly-off flights, one for compulsory and one for music freestyle schedule. The normalised results of the preliminary rounds for the top 10 pilots plus the two fly-off scores provide three normalised scores with the best two to count for the final individual classification.

At national and open international competitions the preliminary/fly-off system is not mandatory. ||

Ties will be broken by counting the throwaway score. If the tie still stands, a “sudden death” freestyle fly-off must take place until a decision is made.

5F.9 ORGANISATION

The flight order for the first compulsory round will be determined by a random draw. The flight order for rounds two (freestyle), three (compulsory) and four (music freestyle) will start after the first, second and third quarter of the initial order. ||

Preparation Time:

A competitor must be called at least 5 minutes before he is required to enter the start box. The MA may be hovered only up to 2m in the start box.

After the preceding competitor has finished his flight, the competitor is given another minute (two minutes in Freestyle) to make last adjustments or checks, and then his flight time starts.

5F.10 FLIGHT PROGRAM

Freestyle Compulsory

Every pilot makes his choice of eight different manoeuvres from the list of manoeuvres (ref paragraph 5F.11). He may choose different manoeuvres for each round.

The list with the manoeuvres chosen for a round must be delivered to the Contest Director or an official before the beginning of the round.

The flight time in the compulsory rounds is eight minutes.

Freestyle Unlimited

Each competitor is given a flight timeframe of at least three, max five minutes. During this time there are no restrictions for the flight or the performed manoeuvres except the safety line. The play-back of music is not allowed. The flight time begins when the helper gives a distinctive hand signal and finishes only with another distinctive helper hand signal.

Music Freestyle

The same criteria as in Freestyle, but the play-back of music during the flight is prescribed. The flight time begins when the helper gives a distinctive hand signal and finishes only with another distinctive helper hand signal. ||

Performance of the Schedules

The competitor may choose his position during the flight with the following constraints:

- (a) The MA must not fly between the pilot and judges.
- (b) The MA must be kept at a safe distance of at least twenty metres from the judges (i.e. helipad).
- (c) The pilot must stand in front of the judges.

The non-observance of these constraints will be penalised by a zero score for the manoeuvre.

FIGURE 5F.A - CONTEST AREA LAYOUT

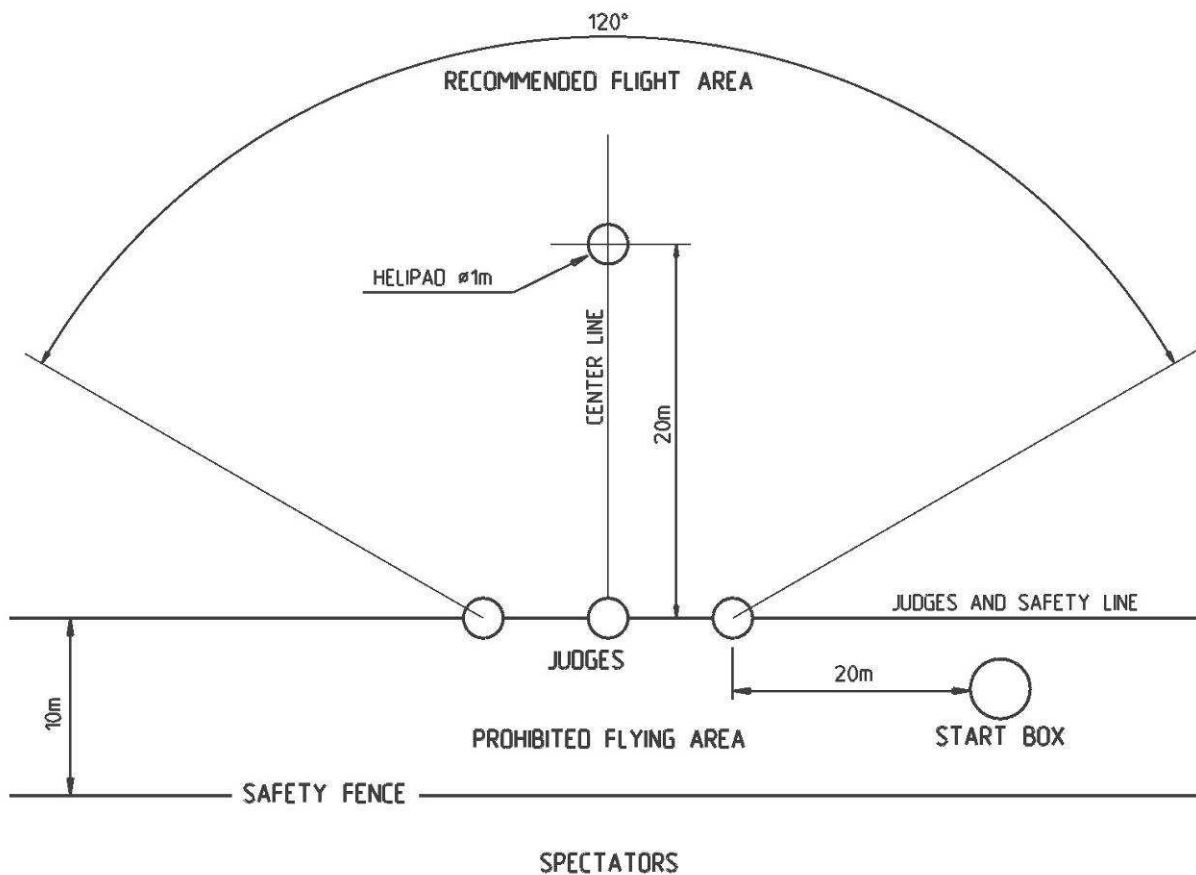

5F.11 COMPULSORY MANOEUVRE DESCRIPTIONS

General:

The competitor or his caller must announce the name and start and finish of each manoeuvre. All aerobatic manoeuvres start and end with a straight and level flight of 10 metres minimum length parallel to the judges line. All manoeuvres from stationary flight start and end with a hovering of at least 1 second with the MA parallel or vertical to the flight line. All manoeuvres (considering also entry and exit) should be performed symmetrical to the centre line. For safety reasons, a minimum altitude of 2 metres for all compulsory manoeuvres should be kept. If the engine is running during the autorotation there will be a downgrade of 4 points by each judge. If the engine is still running during the landing after an autorotation the score will be zero. The drawings in Annex C shall illustrate the manoeuvres, in case of a dispute the following text takes precedence over the drawings. All manoeuvres can also be flown in opposite direction as shown in the drawings.

Number	Name	K-Factor
1.	Split-S	3
MA performs a half roll immediately followed by a half inside loop to upright flight in opposite direction.		
2.	Inverted hovering	3
MA approaches slowly in inverted flight, stops in an altitude of 5-10 metres for at least 2 seconds and transitions to a slow inverted forward flight.		
3.	Inside loop	3,5
MA performs an inside loop.		
4.	Inverted pirouette	3,5
MA hovers in inverted flight and performs a slow (at least 4 seconds) 360°pirouette, maintaining its lateral position.		
5.	Backward circle	3,5
MA enters the manoeuvre backwards in upright flight and performs a horizontal circle aligned to the centre line.		
6.	Double Immelmann	4
MA performs a half inside loop immediately followed by a half roll to upright flight. After a straight flight of about 20 metres MA performs a half outside loop, again immediately followed by a half roll to upright flight.		
7.	2-point roll	4
MA enters in upright flight, then performs a half roll followed by a recognizable straight segment in inverted flight and another half roll back to upright flight.		
8.	Double roll backwards	4,5
MA enters in upright backward flight and performs two consecutive axial rolls.		
9.	4-point roll	4,5
MA enters in upright forward flight and then performs 4 quarter rolls, separated each by a recognizable straight segment of the same duration.		
10.	Backward horizontal eight	5
MA enters in upright backward flight parallel to the judges' line, performs a 90°turn to a straight flight above the centre line and then performs a horizontal eight, consisting of two 360°circles.		
11.	Outside loop with half rolls	5
MA performs a half roll to inverted flight, followed by a recognisable straight segment and then enters an outside loop (upward). After the loop, MA flies another recognizable straight segment, followed by a half roll to upright flight.		
12.	Inverted horizontal eight	5
MA enters in inverted forward flight parallel to the judges' line, performs a 90°turn to a straight flight above the centre line and then performs a horizontal eight, consisting of two 360°circles.		

13. Backward knife edge pirouette 5,5
MA enters in upright backward flight, transitions to a slight ascent (max 15°) and performs a quarter roll. After a recognizable straight segment MA performs a 360°-pirouette, followed by another straight segment and a quarter roll in opposite direction to the first to upright backward flight.
14. Four pushed half flips 5,5
MA hovers in upright position, then performs four half pushed flips (forward) separated each by a hovering of about 2 seconds. MA maintains its position during the manoeuvre.
15. Loop sideways 5,5
MA enters in upright sideward flight and performs an inside loop with the longitudinal axis always vertical to the flight path.
16. Tic-toc (Metronome) 6
MA hovers or moves slowly and is brought to vertical position (Nose up). It maintains its position by rotating alternately about the tail rotor shaft axis by about 45° in each direction. Both 45° positions have to be reached at least three times. The tail rotor stays almost in the same position during the manoeuvre.
17. 0°turn with half roll 6
MA enters in upright backward flight and performs a quarter inside loop to a vertical climb and a stop. During the following dive MA performs a half roll and a quarter outside loop to inverted forward flight.
18. Backward loop 6,5
MA enters in upright backward flight and performs an inside loop with the tail always pointing in flight direction.
19. 360°turn with roll 6,5
MA enters in upright forward flight and performs a quarter (inside) loop to a vertical climb. Just before the stall, MA performs a 360°-pirouette to a vertical (backward) dive, followed by another quarter (inside) loop to upright flight and an axial backward roll.
20. Backward 4-point roll 6,5
MA enters in upright backward flight and then performs 4 quarter rolls, separated each by a recognizable straight segment of the same duration. The tail of the MA always points in the flight direction.
21. Inverted autorotation 6,5
MA enters in an altitude of at least 30 metres in inverted flight. The engine must be off and the MA descends in the inverted autorotative state for about 5 seconds. Then it is brought to upright position, either by a half roll or a flip and descends to a smooth landing on the helipad.
22. Inverted backwards horizontal eight 7
MA enters in inverted backward flight parallel to the judges line, performs a 90°-turn to a straight flight above the centre line and then performs a horizontal eight, consisting of two 360° circles with the tail always pointing in flight direction.
23. Rolling circle 7,5
MA performs a horizontal circle while it performs consecutive axial rolls. MA speed, rolling rate and the radius of the circle should be constant.
24. Four rainbows with half rolls 7,5
MA performs a rainbow (a semicircle with the lateral axis always vertical to the flight path) to a recognisable stop, then a stationary half roll to another stop. Then it enters another rainbow to a stop on the position of the start of the manoeuvre, followed by another half roll and continues like that, until four rainbows and four half rolls are completed.
25. Funnel 7,5
MA enters in inverted forward flight and performs a quarter pirouette. MA then performs three superimposed circles in lateral inverted flight with the rotor disk tilt at least 45 degree from a horizontal plane. The diameter of the circles should be at least 10 metres.
26. Snake 8
MA enters in upright backward flight and then describes a sinuous line by alternately performing upright and inverted circle segments of equal diameter and length. There should be at least four complete circle segments and the length of the manoeuvre should be at least 50 metres.

27. Inverted pirouetting circle 8
MA enters in inverted flight and performs a horizontal circle while performing consecutive pirouettes. MA speed, pirouetting rate and the radius of the circle should be constant.
28. Triple pirouetting flip 8
MA hovers or moves slowly and then starts pirouetting. At the same time or after one pirouette the MA starts to flip three times while it continues to perform pirouettes. There should be at least one pirouette during each 360° flip (2 pirouettes are shown in the drawing). Both rotations should have a constant rate and the MA maintains its position during the manoeuvre.
29. Pirouetting loop 8,5
MA enters in upright flight and starts performing pirouettes. Then it performs an inside loop while constantly rotating about the yaw axis. During the loop there have to be at least 2, max 6 pirouettes. The pirouettes should be distributed equal on the loop.
30. Cuban eight backwards 8,5
MA enters in upright backward flight and performs a 5/8 inside loop to a 45°-descent. It performs a half roll, followed by a 3/4 inside loop and another half roll in 45°-descent. MA then finishes the first partial loop to upright backward flight. The tail of the MA always points in the flight direction.
31. Backward rolling circle 8,5
MA enters in backward flight and performs a horizontal circle while it performs consecutive axial rolls. MA speed, rolling rate and the radius of the circle should be constant and the tail of the MA always points in the flight direction.
32. Four 270°-Turns 9
MA enters in upright backward flight and performs a quarter loop to vertical flight. On the top the MA performs a 270 degree turn to a vertical descend sideways, followed by a half inverted loop sideways to vertical flight and another 270 degree turn in the same direction as the first. MA continues until 4 turns (all in the same direction) are completed and exits in upright backward flight.
33. Double 4-point Tic-toc (Metronome) 9
MA hovers or moves slowly and is brought to vertical position (Nose up). It maintains its position by rotating alternately about the lateral axis for about 45° in each direction. Both 45°-positions have to be reached one time (i.e. one tic-toc) and then the MA performs a quarter pirouette. It performs another complete tic-toc in this position, then again performs another quarter pirouette and so on, until it performed two complete pirouettes while executing tic-tocs.
34. Rolling rotation 9
MA hovers and then performs at least six stationary rolls while its lateral axis rotates about 360 degree (viewed from above)
35. Diamond (Bavarian rhomb) 9
MA enters in upright forward flight and over the centre line it performs a 45° pushed flip and enters a 45° climb of at least 20 metres length. After a pushed 90° flip it climbs for another 20 metres under 45° back to the centre line where it performs another quarter pushed flip. It descends under 45° to another quarter pushed flip and a final descend back to the centre line and then exits the manoeuvre in upright flight. During the 45° ascends/descends the longitudinal axis of the MA should be almost perpendicular to the flight path.
36. Pirouetting funnel 9,5
MA enters in inverted flight and then starts pirouetting whereas it performs three superimposed circles in lateral inverted flight with the rotor disk tilt at least 45 degree from a horizontal plane. The diameter of the circles should be at least 10 metres and there should be at least three pirouettes during each circle.
37. Funnel with half rolls 9,5
MA enters in inverted forward flight and performs a quarter pirouette. MA then performs three superimposed circles in lateral inverted flight with the rotor disk tilt at least 45 degree from a horizontal plane. After each half funnel except the last the MA performs a half roll. After three funnels (and five half rolls) the MA exits in upright forward flight. The diameter of the circles should be at least 10 metres.

38. Square of rainbows 10
 MA hovers and enters the manoeuvre with a rainbow, i.e. a not stationary flip that follows a semi-circular flight path of at least 10 metres diameter. On top of the rainbow the MA performs a half flip about the axis, that is vertical at this point (e.g. on a pulled rainbow the MA performs a flip about the longitudinal axis (like a half roll); on a rainbow flown sideways it performs a half (pushed or pulled) flip). MA then hovers and enters another rainbow, alternately about the longitudinal and the lateral axis, until it reaches the starting position after the fourth rainbow. The four hovering positions between the rainbows are situated on the edges of a square of at least 10 metres.
39. Pirouetting tic-toc (Metronome) 10
 MA hovers or moves slowly and is brought to vertical position (Nose up). It maintains its position by rotating alternately about the lateral or the longitudinal axis for about 45° in each direction while it performs pirouettes of a constant rate. Both 45°-positions have to be reached at least three times (i.e. three tic-tocs) and also there has to be at least one complete pirouette on each tic-toc.
40. Pirouetting globe 10
 MA enters in upright flight and then performs four pirouetting loops. During each loop, the flight path is changed in a way, that the next loop is rotated about 45° (seen from above) until a complete globe has been described. The MA exits the manoeuvre at the same altitude but in opposite direction to the beginning. During each loop, the MA must perform at least two pirouettes.

Note: Manoeuvre diagrams are overleaf.

5F.12 F3N COMPULSORY MANOEUVRE DRAWINGS

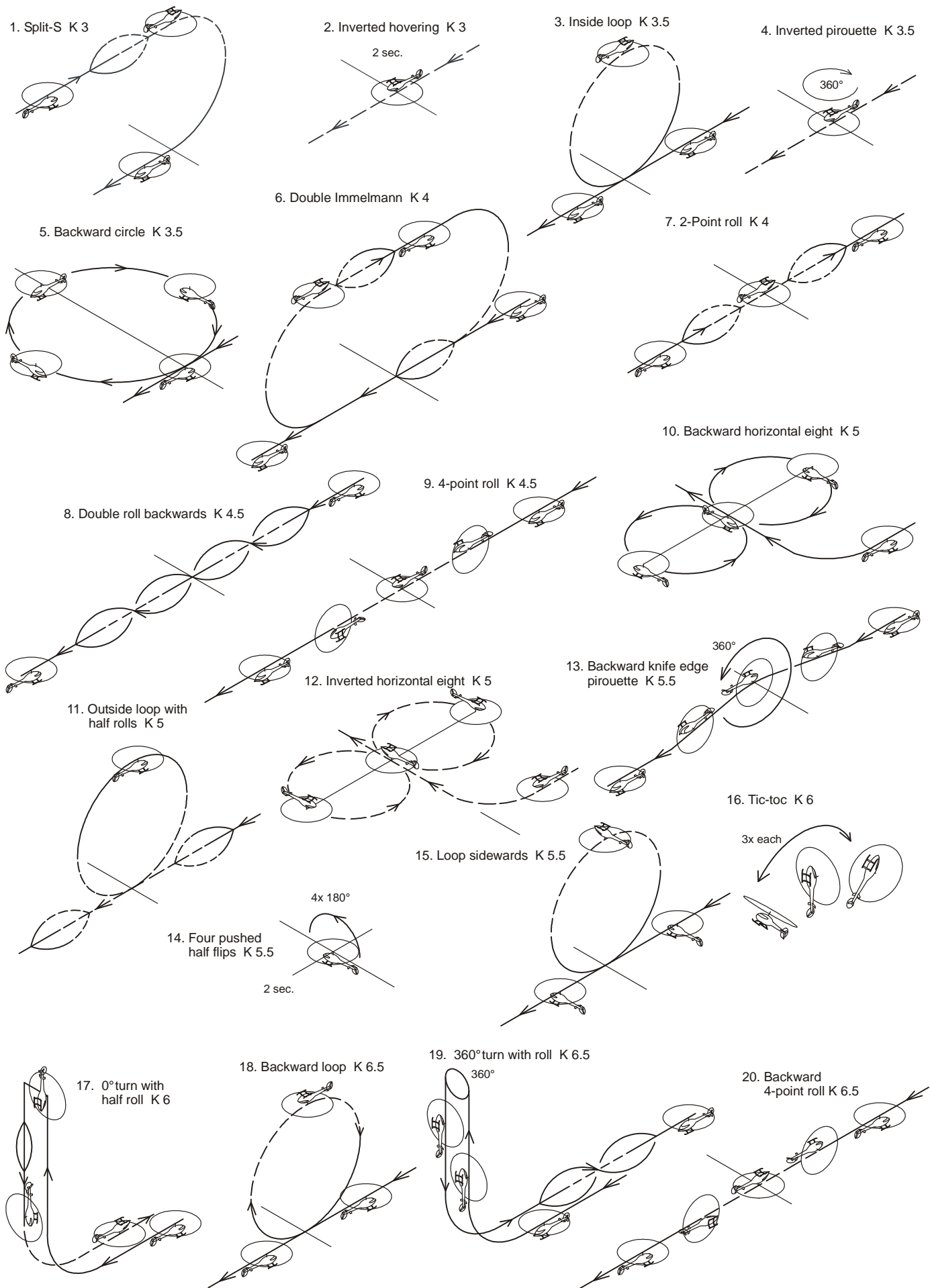

21. Inverted autorotation K 6.5

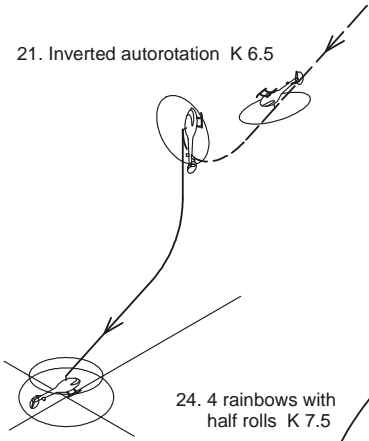

22. Inverted backwards horizontal eight K 7

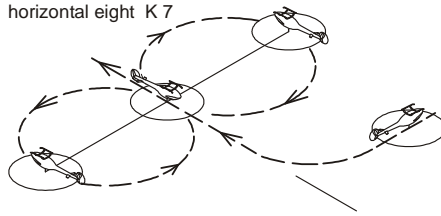

23. Rolling circle K 7.5

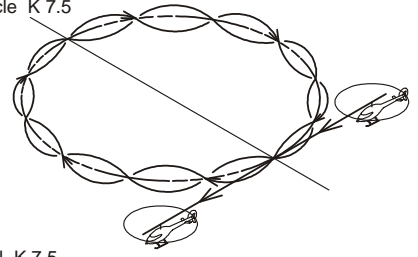

24. 4 rainbows with half rolls K 7.5

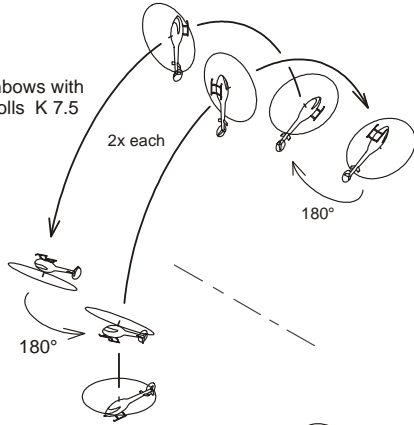

25. Funnel K 7.5

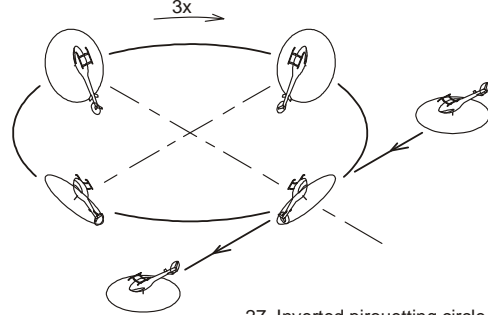

27. Inverted pirouetting circle K 8

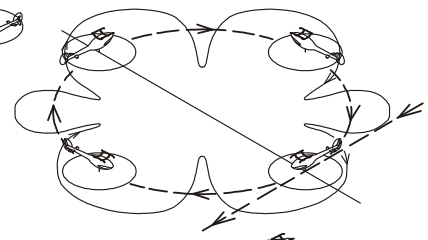

26. Snake K 8

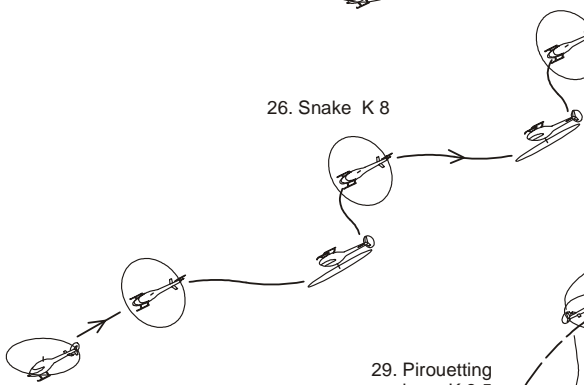

30. Cuban eight backwards K 8.5

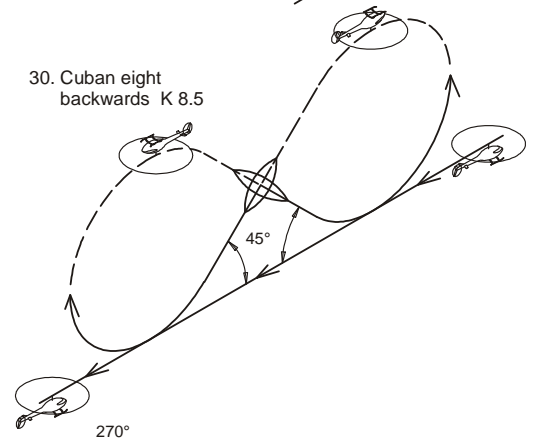

28. Triple pirouetting flip K 8

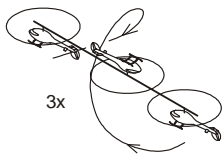

29. Pirouetting loop K 8,5

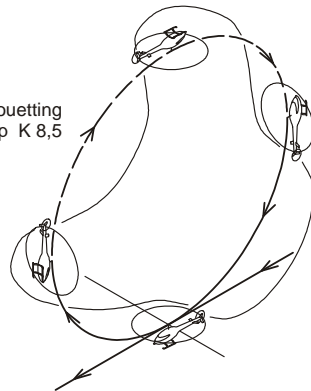

32. Four 270° Turns K 9

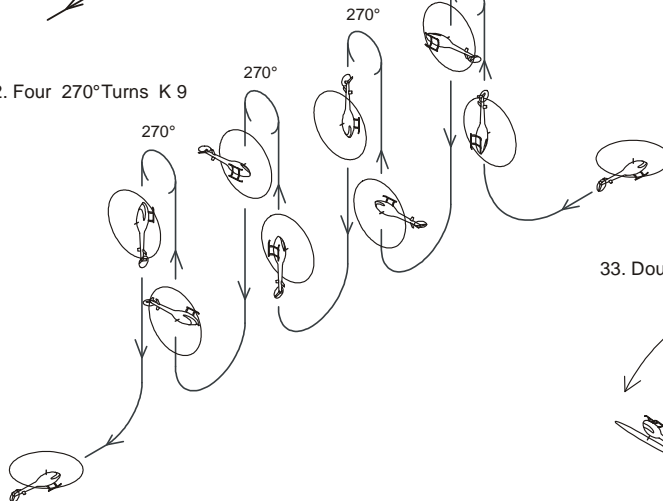

31. Backward rolling circle K 8.5

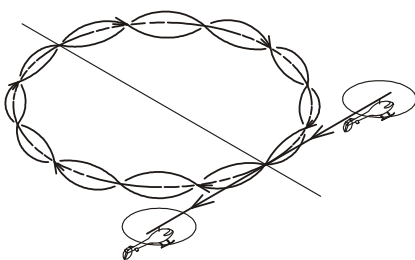

33. Double 4-point tic-toc K 9

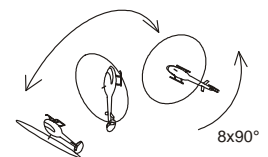

34. Rolling rotation K 9

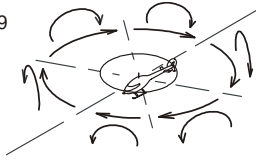

35. Diamond (Bavarian rhomb) K 9

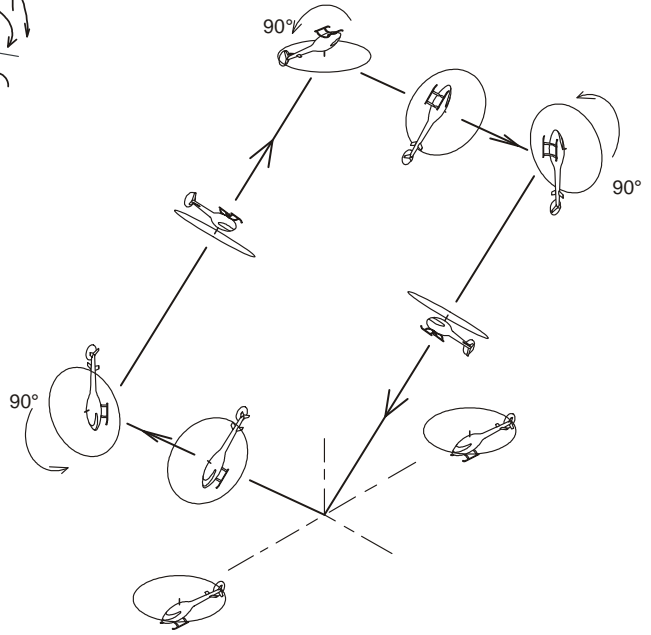

36. Pirouetting funnel K 9.5

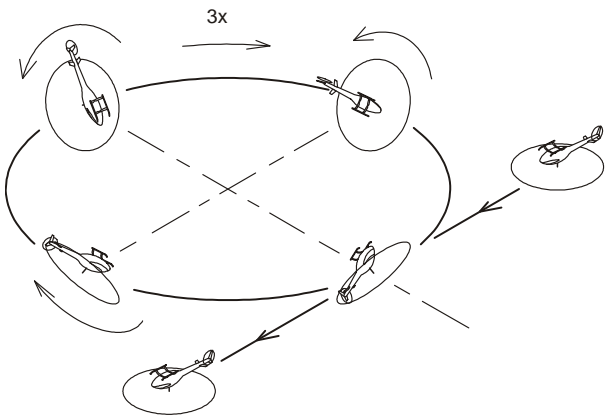

38. Square of rainbows K 10

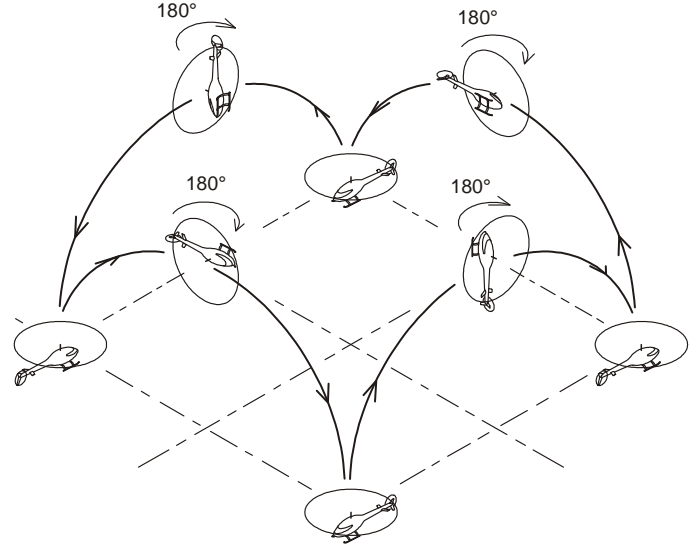

37. Funnel with half rolls K 9.5

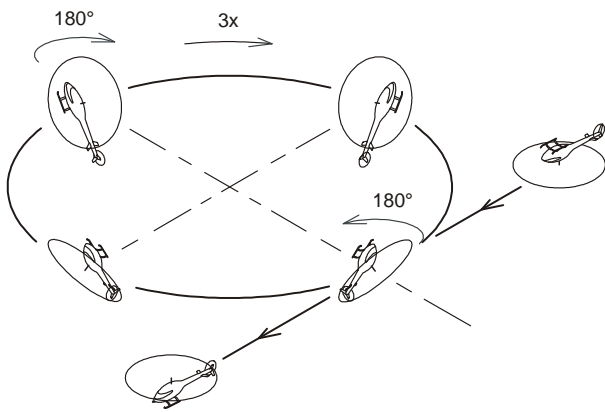

40. Pirouetting globe K 10

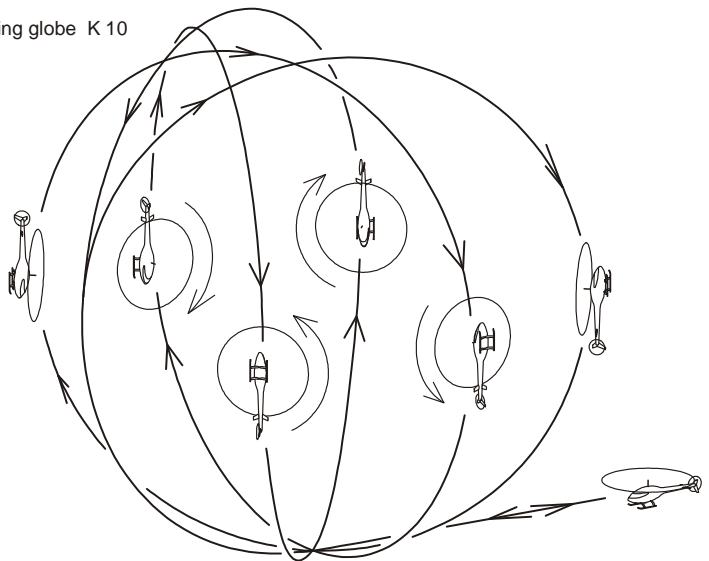

39. Pirouetting tic-toc K 10

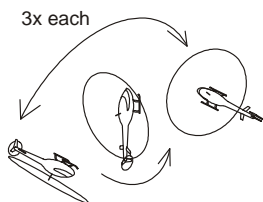

5F.13. EVALUATION OF THE LEVEL OF DIFFICULTY FOR FREESTYLE SCHEDULE

The following spreadsheet gives reference values for the estimation of the level of difficulty for both schedules, unlimited and music freestyle.

Score	Manoeuvres (examples)
6	Immelmann, short inverted passages, loop, loop with full pirouette on top, roll, turn, 540° turn, pi rouettes, autorotation
11	½ Cuban eight, travelling pirouettes, long inverted passages, straight backwards flight, outside loop, vertical rolls, nose-in circle, flips
17	Inverted Immelmann, inverted hovering on eyelevel, circle backwards, loop with half pirouette on top, loop backwards, flip sideways, Cuban eight, flips with hovering stops
22	Horizontal eight backwards, loop sideways, backwards roll, vertical backwards roll, turn with hesitations and/or changes of turning direction, rolling stall turn, autorotation with 180 degree turn, death spiral, autorotation backwards
28	½ Cuban eight backwards, straight inverted backwards flight, stationary inverted nose-in hovering, pirouetting circle, 4-point roll, inverted nose-in circle
34	Inverted circle backwards, outside loop backwards, ½ Cuban eight inverted, turn backwards, knife edge pirouette, inverted speed circle
39	inverted pirouette, ½ Cuban eight sideways, travelling inverted pirouettes, inverted horizontal eight backwards, inverted backwards turn, 4-point roll backwards, rolling circle
45	Loop with flips, nose-in flips sideways, sideward flight with flips, inverted pirouetting circle, stationary tic-toc, funnel, inverted autorotation
49	½ backward Cuban eight inverted, Cuban eight backwards, inverted loop sideways, pirouetting flips
53	Combination of loops with changing direction and/or orientation, inverted funnel, snake, inverted autorotation backwards, inverted speed circle backwards
57	Pirouetting loop, 4-point tic-toc, rolling horizontal eight, rolling circle backwards, circle with flips, Cuban eight sideways, pirouetting autorotation
60	Inverted funnel eight, pirouetting outside loop, rolling circle with reversal, rolling horizontal eight backwards, autorotation with inverted pirouettes
64	Inverted Cuban eight sideways, rolling loop, circle or loop with pirouetting flips, tic-toc circle, rolling autorotation
68	Pirouetting tic-toc, rolling loop backwards, circle or eight with flips in varying directions, pirouetting funnel, inverted Cuban eight backwards
72	Rolling snake, tic-toc with rolls or flips, 4- or more point tic-toc, inverted pirouetting funnel, pirouetting globe, autorotation with pirouetting flips
76	Big Ben, inverted pirouetting globe, pirouetting snake, pirouetting flip with reversal
80	Pirouetting manoeuvres with reversal (loop, globe, funnel, snake tic-toc), autorotation with pirouetting flips and rolls

---oOo---