



FAI Sporting Code

*Fédération
Aéronautique
Internationale*

Section 4 – Aeromodelling

Volume F3 Radio Control Model Helicopters

2021 Edition-Version 2

Effective 1st July 2021

Early implementation changes to the 2021 Volume

F3C – RC AEROBATIC HELICOPTERS
F3N – RC FREESTYLE AEROBATIC HELICOPTERS
ANNEX 5D – F3C MANOEUVRE DESCRIPTIONS & DIAGRAMS
ANNEX 5E – F3C JUDGES' GUIDE
ANNEX 5F – F3N MANOEUVRE DESCRIPTIONS & DIAGRAMS
ANNEX 5G – F3N JUDGES' GUIDE
ANNEX 5H – RADIO CONTROL MODEL HELICOPTERS WORLD
CUP RULES

*Maison du Sport International
Avenue de Rhodanie 54
CH-1007 Lausanne
Switzerland
Tel: +41(0)21/345.10.70
Fax: +41(0)21/345.10.77
Email: sec@fai.org
Web: www.fai.org*

FEDERATION AERONAUTIQUE INTERNATIONALE
MSI - Avenue de Rhodanie 54 – CH-1007 Lausanne – Switzerland

Copyright 2021

All rights reserved. Copyright in this document is owned by the Fédération Aéronautique Internationale (FAI). Any person acting on behalf of the FAI or one of its Members is hereby authorised to copy, print, and distribute this document, subject to the following conditions:

- 1. The document may be used for information only and may not be exploited for commercial purposes.**
- 2. Any copy of this document or portion thereof must include this copyright notice.**
- 3. Regulations applicable to air law, air traffic and control in the respective countries are reserved in any event. They must be observed and, where applicable, take precedence over any sport regulations.**

Note that any product, process or technology described in the document may be the subject of other Intellectual Property rights reserved by the Fédération Aéronautique Internationale or other entities and is not licensed hereunder.

RIGHTS TO FAI INTERNATIONAL SPORTING EVENTS

All international sporting events organised wholly or partly under the rules of the Fédération Aéronautique Internationale (FAI) Sporting Code¹ are termed *FAI International Sporting Events*². Under the FAI Statutes³, FAI owns and controls all rights relating to FAI International Sporting Events. FAI Members⁴ shall, within their national territories⁵, enforce FAI ownership of FAI International Sporting Events and require them to be registered in the FAI Sporting Calendar⁶.

An event organiser who wishes to exploit rights to any commercial activity at such events shall seek prior agreement with FAI. The rights owned by FAI which may, by agreement, be transferred to event organisers include, but are not limited to advertising at or for FAI events, use of the event name or logo for merchandising purposes and use of any sound, image, program and/or data, whether recorded electronically or otherwise or transmitted in real time. This includes specifically all rights to the use of any material, electronic or other, including software that forms part of any method or system for judging, scoring, performance evaluation or information utilised in any FAI International Sporting Event⁷.

Each FAI Air Sport Commission⁸ may negotiate agreements, with FAI Members or other entities authorised by the appropriate FAI Member, for the transfer of all or parts of the rights to any FAI International Sporting Event (except World Air Games events⁹) in the discipline¹⁰, for which it is responsible¹¹ or waive the rights. Any such agreement or waiver, after approval by the appropriate Air Sport Commission President, shall be signed by FAI Officers¹².

Any person or legal entity that accepts responsibility for organising an FAI Sporting Event, whether or not by written agreement, in doing so also accepts the proprietary rights of FAI as stated above. Where no transfer of rights has been agreed in writing, FAI shall retain all rights to the event. Regardless of any agreement or transfer of rights, FAI shall have, free of charge for its own archival and/or promotional use, full access to any sound and/or visual images of any FAI Sporting Event. The FAI also reserves the right to arrange at its own expense for any and all parts of any event to be recorded.

-
- 1 FAI Statutes,Chapter 1, para. 1.6
 - 2 FAI Sporting Code, Gen. Section,Chapter 4, para 4.1.2
 - 3 FAI Statutes,Chapter 1, para 1.8.1
 - 4 FAI Statutes,Chapter 2, para 2.1.1; 2.4.2; 2.5.2 and 2.7.2
 - 5 FAI By-Laws,Chapter 1, para 1.2.1
 - 6 FAI Statutes,Chapter 2, para 2.4.2.2.5
 - 7 FAI By-Laws,Chapter 1, paras 1.2.2 to 1.2.5
 - 8 FAI Statutes,Chapter 5, paras 5.1.1, 5.2, 5.2.3 and 5..2.3.3
 - 9 FAI Sporting Code, Gen. Section,Chapter 4, para 4.1.5
 - 10 FAI Sporting Code, Gen. Section,Chapter 2, para 2.2.
 - 11 FAI Statutes,Chapter 5, para 5.2.3.3.7
 - 12 FAI Statutes,Chapter 6, para 6.1.2.1.3

PAGE DELIBERATELY LEFT BLANK

VOLUME F3 HELICOPTERS

SECTION 4C – MODEL AIRCRAFT – F3 HELICOPTERS

Part Five – Technical Regulations for Radio Controlled Contests

5.4. F3C RC Aerobatic Helicopters

Annex 5D – F3C Manoeuvre Description & Diagrams

Annex 5E – F3C Judges' Guide

5.11 F3N RC Freestyle Aerobatic Helicopters

Annex 5F – F3N Manoeuvre Description & Diagrams

Annex 5G – F3N Judges' Guide

Annex 5H – Radio Control Model Helicopters World Cup Rules

THIS 2021 VERSION 2 EDITION INCLUDES THE FOLLOWING AMENDMENTS MADE TO 2021 CODE

Amendments to Annex 5F have been updated with a double line in the right margin of this edition.

Paragraph	Plenary meeting approving change	Brief description of change	Change incorporated by
Annexes	2021		Kevin Dodd Technical Secretary & Stefan Wolf, F3 Helicopter S-C Chairman
F3N			
Annex 5F.1		Rewrite manoeuvres 1.5, 1.9, 1.11, 1.12, 1.16, 1.17, 1.18, 1.19, 1.20, 1.21, 1.22, 1.23, 1.24, 1.25, 1.26, 1.27, 1.28, 1.29, 1.30	
Annex 5F.2		Replace F3N Set Manoeuvre drawing 1-17.	

Paragraph	Plenary meeting approving change	Brief description of change	Change incorporated by
<p>There were no changes at the 2020 Plenary Meeting. The F3N Optional Manoeuvres were not changed in 2020.</p>			

Four-Year Rolling Amendments for Reference			
Paragraph	Plenary meeting approving change	Brief description of change	Change incorporated by
F3C	2019		Kevin Dodd Technical Secretary & Stefan Wolf, F3 Helicopter S-C Chairman
5.4.8		Addition of semi final flights.	
5.4.11		Consequence of addition of semi final flights.	
5.4.12		Consequence of addition of semi final flights.	
5.4.13		Consequence of addition of semi final flights.	
5.4.14		Consequence of addition of semi final flights.	
Annexes			
Annex 5D		Addition of SF schedule for semi final flights; change of time to 8 minutes for SF/F schedule.	
Annex 5D		New schedules listed for F3C 'P' schedule. Schedule descriptions P1-P9 replaced except for P3 & P7.	
Annex 5D		New SF/F schedule to replace the old F schedule for F3C. Consequence of addition of semi final flights.	
Annex 5D		Replace F3C Manoeuvre drawings.	
F3N			
Annex 5F.1		Change k-factor of 1.5, 1.17, 1.29 Replace manoeuvres 1.10, 1.11, 1.16, 1.30 Rewrite manoeuvre 1.28	
Annex 5F.2		Replace F3N Set Manoeuvre drawings.	
Annex 5F.3	n/a	Class F3N Optional Manoeuvre List is set annually.	

Four-Year Rolling Amendments for Reference			
Paragraph	Plenary meeting approving change	Brief description of change	Change incorporated by
F3N	2018		Kevin Dodd Technical Secretary & Stefan Wolf, F3 Helicopter S-C Chairman
5.11.10.		Effective 01/06/18. Reduce the number of set manoeuvres from eight to seven.	
Annexes			
5E.6.11.		Effective 01/06/18. Autorotations. Entire section rewritten for clarification.	
5G.8.6		Effective 01/06/18. Amendments to the table of values for the level of difficulty for both schedules, unlimited and music freestyle.	
5F.3	n/a	Class F3N Optional Manoeuvre List is set annually.	

cont/...

Paragraph	Plenary meeting approving change	Brief description of change	Change incorporated by
F3C	2017		Kevin Dodd Technical Secretary & Stefan Wolf, F3 Helicopter S-C Chairman
5.4.A		Addition of 2 flags to mark the 120 degree window in contest area.	
F3N			
5.11.6.		Same start/finish signal for all programs.	
5.11.9.		Clarification to unify preparation time.	
Annexes			
5D.2.		Clarification. Slight addition to judging criteria to align with schedule.	
5E.6.11.		Autorotations. Entire section rewritten for clarification.	
5F		New set manoeuvres.	
5F.1.28		Effective 01/06/17. <i>Duus Igloo</i> rewritten due to safety.	
5G.8.		Effective 01/06/17. Further clarification to criteria for judging freestyle and music freestyle points table.	
5G.8.1.		Effective 01/06/17. Clarification.	
5F.3	n/a	Class F3N Optional Manoeuvre List is set annually.	

Paragraph	Plenary meeting approving change	Brief description of change	Change incorporated by
Contents & subsequent references	2016	Minor changes in the names of F3C and F3N in line with 2017 CIAM Classes document.	Kevin Dodd Technical Secretary & Dag Eckoff, F3 Helicopter S-C Chairman
Throughout		Upgrade previous cross references to ABR to the corresponding paragraph in CIAM General Rules.	
5.4.2.		Change to refer to CIAM General Rules (C.5.1.2) - does not now require competitor to build model.	
5.4.11. & 5.11.8.		Team Classification method quoted from CIAM General Rules C.15.6.2 (clarification).	
Annex 5E		F3C Judges' Guide	
5E.6.11.		Effective 01/05/16. Autorotations. Entire section rewritten for clarification.	
Annex 5G		F3N Judges' Guide	
5G.6.7.		Effective 01/05/16. New text added to differentiate between a pushed flip and pulled flip.	
5G.8.6.		Effective 01/05/16. Level of difficulty for freestyle schedule table replaced.	
5G.8.		Effective 01/05/16. Criteria for judging freestyle and music freestyle points table amended. K-Factors amended for music freestyle.	
Annex 5H		World Cup Rules	
5H.10.		Appropriate form of CIAM General Rules C.7.4 used for definition of World Cup Board.	
Annex 5F 5F.3	n/a	Class F3N Optional Manoeuvre List is set annually.	

RULE FREEZE FOR THIS VOLUME

With reference to paragraph A.10.2 of CIAM General Rules:

In all classes, the two-year rule for no changes to model aircraft/space model specifications, manoeuvre schedules and competition rules will be strictly enforced. For Championship classes, changes may be proposed in the year of the World Championship of each category.

For official classes without Championship status, the two-year cycle begins in the year that the Plenary Meeting approved the official status of the class. For official classes, changes may be proposed in the second year of the two-year cycle.

This means that in Volume F3 Helicopters:

- (a) changes for F3C and F3N can next be agreed at the Plenary meeting 2021 for application from January 2022; note that F3N optional manoeuvres are set annually and approved by CIAM Bureau.
- (b) provisional classes are not subject to this restriction.

The only exceptions allowed to the two-year rule freeze are genuine and urgent safety matters, indispensable rule clarifications and noise rulings.

VOLUME F3 HELICOPTERS

PART FIVE - TECHNICAL REGULATIONS FOR RADIO CONTROLLED CONTESTS

5.4. CLASS F3C – RC AEROBATIC HELICOPTERS

5.4.1. Definition of a Radio Controlled (R/C) Helicopter

An R/C helicopter is a heavier-than-air model aircraft (MA) that derives all of its lift and horizontal propulsion from a power driven rotor system(s) rotating about a nominally vertical axis (or axes). Fixed horizontal supporting surfaces up to 4% of the swept area of the lifting rotor(s) are permitted. A fixed or controllable horizontal stabiliser of up to 2% of the swept area of the lifting rotor(s) is permitted. Ground effect machines (hovercraft), convertiplanes or aircraft that hover by means of propeller slipstream(s) deflected downward are not considered to be helicopters.

5.4.2. Builder of the Model Aircraft

There is no requirement for the competitor to be the builder of the model in F3C. Refer C.5.1.2. in *CIAM General Rules*.

5.4.3. General Characteristics

- a) AREA: The swept area of the lifting rotor cannot exceed 250dm². For helicopters with multiple rotors whose rotor shafts are more than one rotor diameter apart the total swept area of both rotors cannot exceed 250dm². For helicopters with multiple rotors whose rotor shafts are less than one rotor diameter apart the swept area of both rotors (counting the area of superposition only once) cannot exceed 250dm². The tail rotor must be driven by the main rotor and must not be driven by a separate engine/motor.
- b) WEIGHT: The weight of the model aircraft (with fuel / with batteries) must not exceed 6.5 kg.
- c) MOTOR: Internal combustion engine displacement: no restrictions.
Electric motors are limited to a maximum no load voltage of 51 volts for the propulsion circuit.
- d) GYROS: The use of pre-programmed flight manoeuvres is forbidden. The use of automatic position (latitude and longitude) locking devices and altitude locking devices, whether with external references or not, are forbidden.
- e) ROTOR BLADES: All-metal main or tail rotor blades are prohibited.

5.4.4. Noise Limit

Noise level measurements must be made before the start of a competition, preferably during the official practice day. The noise level must be measured at a distance of 3m (3 metres) while the helicopter is hovering with the skids/landing gear at 2m over the centre of a 2m diameter circle. A remote microphone mounted on a tripod must be used. The engine speed (RPM) must be the same as that used during the hovering portion of the flight schedules. During the measurement the helicopter must be rotated through 360° to determine the maximum noise level. The sound pressure level must not exceed 87dB (A) over a soft (grass) surface or 89dB (A) over a hard (asphalt, concrete, etc) surface. If the noise level limit is exceeded during the first measurement, two additional measurements must be made to substantiate the excessive noise level. The competitor may modify the helicopter and/or silencer system to reduce the noise level and after verification of an acceptable level, will be permitted to fly. If the noise level cannot be reduced to or below the noise level limit it will not be allowed to fly in the competition. The measuring equipment must be calibrated to the dB (A) sound pressure level scale defined in applicable ISO Standards. If noise measuring equipment that can be calibrated to ISO Standards is not available, the measurements will be advisory only and no competitor can be excluded from the competition.

5.4.5. Contest Area Layout

See FIGURE 5.4.A. Note: If two flight lines are used they must be parallel, operate simultaneously, face in the same direction and be separated by a minimum of 500m for a "front-to-back configuration" or a minimum of 1000m for a side-by-side configuration.

5.4.6. Number of Helpers

Each competitor is allowed only one mechanic/caller. The mechanic/caller must announce the start, finish and name or number of each manoeuvre, and should inform the pilot of wind direction, remaining flight time, proximity to prohibited areas and intrusions into the flight area.

Team managers may observe the flight from a position 5m behind the judges and away from the start circle. Team managers may serve as mechanic/caller if no separate person is available for this task.

5.4.7. Number of Model Aircraft

The number of model aircraft eligible for entry is two (2). Model aircraft numbers 1 and 2 may only be exchanged within the start circle. Both model aircraft must use the same radio frequency.

5.4.8. Number of Flights

At Continental and World Championships, each competitor is entitled to four (4) official preliminary flights. After completion of the preliminary flights the top 28 pilots are entitled to two (2) semi final flights. After completion of the semi final flights, the top 14 pilots are entitled to two (2) final flights. At National and Open International Competitions, the preliminary/semi final/final system is not mandatory.

5.4.9. Definition of an Official Flight

There is an official flight when the competitor is officially called. The flight may be repeated if, for any unforeseen reason outside the control of the competitor, the model aircraft fails to make a start such as:

- a) The flight cannot safely be made within the allowed time limit.
- b) The competitor can prove that the flight was hindered by outside interference.
- c) Judging was impossible for reasons beyond the control of the competitor (model aircraft, engine, or radio failures are not considered to be outside the control of the competitor). In such cases the flight **shall** be repeated as close to the published time as possible. The competitor, however, has the right to refuse a reflight.

5.4.10. Scoring

Each manoeuvre is given a score between 0 and 10 (including half) points by each judge. A new score sheet is issued to each competitor for each round. Only the competitor's number (no name or nationality) will appear on the score sheet. Any manoeuvre not completed shall be scored zero (0) points. If a manoeuvre is scored zero points all judges must agree. There shall be an official located on the field where any flight over the prohibited area can be observed. The prohibited area is the shaded area in Figure 5.4.A behind the judges' line. The area extends to infinity to the left, right and rear. A visual or audible signal shall be given to indicate such over flights. Competitors flying over this area will be penalised by scoring zero (0) points for the current flight. However, the judges shall score all manoeuvres. If an infringement has been made, the scores will be deleted from all score sheets after the flight. In addition, there shall be no score when:

- a) The competitor flies a model aircraft that has been flown in the same competition by another competitor, or flies a model aircraft that does not comply with the definition and general characteristics of a radio controlled helicopter.
- b) The competitor does not deliver his transmitter to the impound or operates any transmitter at the competition area during a round without permission.
- c) The competitor starts his model aircraft outside of the start circle.
- d) The competitor gets his transmitter from the impound before he is officially called.
- e) Manoeuvres must be performed where they can be seen clearly by the judges. If a judge, for some reason beyond the control of the competitor, is not able to follow the model aircraft through the entire manoeuvre, he may put a "Not Observed" (N.O.) mark. In this case, his score will, for that particular manoeuvre, be set to the average score given by the other judges, rounded to the nearest half point.

cont/...

5.4.11. Classification

Part of Competition	# of Competitors	# of Rounds	Classification	Ranking
Preliminary	All registered and qualified pilots	4	Sum of normalized points of each of the four rounds. Dropping the lowest result, only if there are at least 3 completed rounds	Determines the ranking of pilots classified 29... n
Semi-Final	Top 28 pilots of preliminary part of competition	2	Sum of normalized points of each of the two rounds plus the normalized result of the preliminary part of the competition. Dropping the lowest of any of these 3 results, only if there were 2 semi-final rounds completed.	Determines the ranking of pilots classified 15..28
Final	Top 14 pilots of semi-final part of competition	2	Sum of normalized points of each of the two rounds plus the normalized result of the semi-final part of the competition. Dropping the lowest of any of these 3 results, only if there were 2 final rounds completed.	Determines the ranking of pilots classified 1..14

The finals to determine the individual classification are only required for World and Continental Championships.

If the competition is interrupted, the final individual classification will be determined by counting all completed rounds and by calculating according to the table above.

All scores for each round will be normalised by awarding 1000 points to the highest scoring flight. The remaining scores are then normalised to a percentage of the 1000 points in the ratio of actual score over the score of the winner of the round. If only one round is possible then the classification will be based on that one round.

For example:

$Points_{(x)} = Score_{(x)}$ divided by $Score_{(w)}$ multiplied by 1000

Where $Points_{(x)}$ = Points awarded to competitor X

$Score_{(x)}$ = Score of competitor X

$Score_{(w)}$ = Score of winner of the round

$Points_{(x)}$ should be calculated to at least two decimal places and recorded (truncated) to two places after decimal point.

Ties for any of the first three places will be broken by counting the highest throwaway score. If the tie still stands a "sudden death" final must take place within one hour of the end of the scheduled final rounds.

The team classification for World and Continental Championships is established at the end of the competition (after the final flights) by adding together the numerical final placings of the three team members using the full list of competitors unless there is a fourth member of the team (who must always be a junior) in which case it will be the three best placed members. Teams are ranked from the lowest numerical scores to the highest, with complete three-competitor teams ahead of two-competitor teams, which in turn are ranked ahead of one-competitor teams. In case of a tie, the best individual placing decides the team ranking. (Ref: *CIAM General Rules*, C.15.6.2 i)

5.4.12. Judging

At Continental and World Championships the organiser must appoint a panel of five judges for each round/flight line. When the entry exceeds 55, two flight lines must be used. The judges must be of different nationalities and must be selected from the current CIAM list of international judges. When using two separate panels, the organiser is allowed to use two judges of the same nationality, one on each panel. Those selected must reflect the approximate geographical distribution of teams participating in the previous World Championship with the final list approval by the CIAM Bureau.

At least 20% but not more than 40% of the judges must not have judged at the previous World Championships.

For the preliminary rounds the final score of each flight is obtained by deleting the highest and lowest scores for each manoeuvre from the five judges. This also applies for semi final and final rounds if only one flight line is used. If two flight lines were used for the preliminary rounds, for the final and semi final rounds ten judges shall be used while dropping the two lowest and two highest scores for each manoeuvre. At open or other International Competitions the number of judges may be reduced to a minimum of three with no throwaway scores.

- a) There shall be training flights for judges with a debriefing session immediately before a Continental or World Championships.
- b) The scoring system must be organised in such a way that the competitors and the spectators can clearly see the scores awarded by all judges after each flight. The score sheet notation must be written by the judges themselves.

5.4.13. Organisation

TRANSMITTER & FREQUENCY CONTROL (See Volume *CIAM General Rules*, Section C, Paragraph C.16.2). When all transmitters are of the spread spectrum type a transmitter impound is not required.

FLIGHT ORDER

The flight order for the first preliminary round will be determined by a random draw, taking into account that frequency will not follow frequency and team member will not follow team member of the same team. The flight order for preliminary rounds two, three and four will start at the first, second and third quarter of the initial order. The flight order for the first semi final round will be established by a random draw. The flight order for the second semi final round will start at the first half of the initial order. The flight order for the first final round will be established by a random draw. The flight order for the second final round will start at the first half of the initial order.

PREPARATION TIME

A competitor must be called at least 5 minutes before he is required to enter the start circle. A start circle 2m in diameter will be provided away from the flight line, spectators, competitors and model aircraft (see FIGURE 5.4.A). When the previous competitor's flight time reaches 6 minutes the flight line director can give the signal to start the engine. In the case of electric motors, the battery must not be connected before signal has been given. The competitor is given 5 minutes to start the engine and make last minute adjustments. The model aircraft may only be hovered in the start circle up to 2m and must not be rotated beyond 180° left or right relative to the competitor. If the model aircraft is rotated beyond 180° the flight is terminated. The competitor in the start circle must reduce his engine's speed to an idle when the preceding competitor has completed the penultimate manoeuvre. If the competitor is not ready after the 5 minute preparation time, he is allowed to complete his adjustments in the start circle; however, his flight time will have started at the end of the 5 minute interval.

FLIGHT TIME

The flight time of 9 minutes for the preliminary flights and 8 minutes for semi final and final flights begins when the competitor's model leaves the start circle with the permission of the flight line director and the judges. If the allotted time expires before a manoeuvre is completed, that manoeuvre and all remaining manoeuvre(s) will be scored zero.

RESTRICTIONS

After starting the model aircraft in the start circle the model aircraft must be flown at 2m to the helipad along the model entry path shown on the Contest Area Layout (Figure 5.4.A). The pilot may test hover the helicopter on the helipad and reposition it, before announcing the start of the first manoeuvre, to accommodate wind conditions. If the engine stops the flight is terminated.

After the flight: In case of electric motors, the battery must be disconnected before the pilot brings the helicopter over the judging line.

INTERRUPTION OF A COMPETITION

If the wind component perpendicular to the flight line exceeds 8ms/s for a minimum of 20 seconds during a flight, the competition must be interrupted. The flight will be repeated and the competition continued as soon as the wind subsides below the criterion. If the wind does not subside before the round is completed, the entire round will be dropped. The determination will be made by the organiser with concurrence of the FAI Jury.

cont/...

5.4.14. Manoeuvre Schedules

FLIGHT PROGRAM

The flight program consists of manoeuvre schedules P and SF/F for the years 2020 - 2021. The P schedule consists of nine (9) manoeuvres and the SF/F schedule consists of eight (8) manoeuvres (see ANNEX 5D - F3C MANOEUVRE DESCRIPTIONS).

PERFORMANCE OF THE SCHEDULES

The competitor must stand in the 2m circle (labelled P in Figure 5.4.A - F3C Contest Area Layout) located 6m in front of the centre judge. Before the start of the first manoeuvre the pilot may fly or carry the model to the helipad. If the model is flown to the helipad then it must be flown at a height of 2 m (for safety reasons.) Alternatively, the helper may carry the model aircraft to the helipad.

The model aircraft may face left or right but must be parallel with the judges' line.

Each hovering manoeuvre ends with a landing on the helipad and after each landing the model aircraft may be repositioned (but maintains same direction) prior to the next takeoff. After completing the hovering manoeuvres the competitor is allowed one free pass to set up for the flying sequence.

All aerobatics manoeuvres must be performed in an airspace that will allow them to be clearly seen by the judges. This airspace is defined by a field of view up to 60° above the horizon and between lines 60° to the right and left of judges 1 and 5. The non-observance of this rule will be penalised by a loss of points.

The aerobatics manoeuvres must be performed in a smooth flowing sequence, with a manoeuvre performed on each pass before the judges. There are no restrictions on turnaround manoeuvres.

The competitor must perform each listed manoeuvre only once during a flight. The competitor or his caller must announce the name (number) and start and finish of each manoeuvre. A manoeuvre performed out of sequence will result in a zero score for that manoeuvre only. Before the autorotation manoeuvre the competitor is allowed another free pass to accommodate a possible change in wind direction.

5.4.15. Manoeuvre Descriptions and Diagrams

Refer to ANNEX 5D

5.4.16. Judges' Guide

Refer to ANNEX 5E

FIGURE 5.4.A - F3C CONTEST AREA LAYOUT

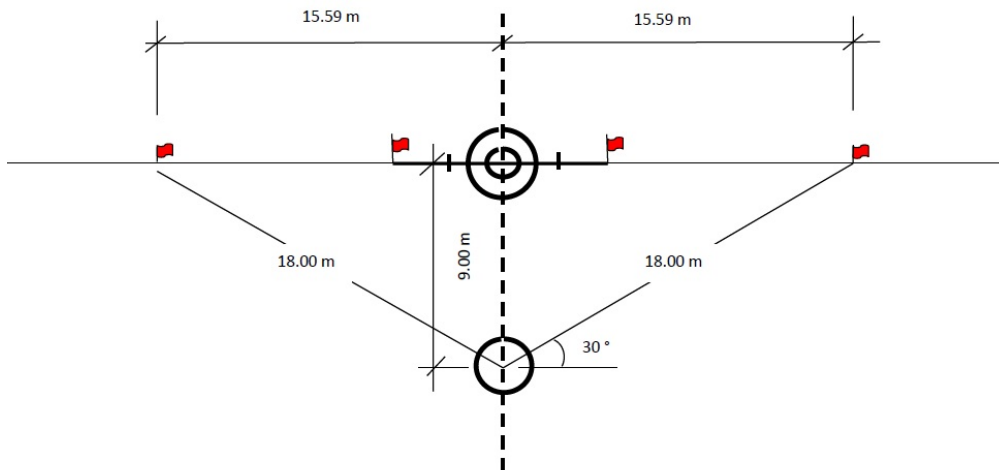
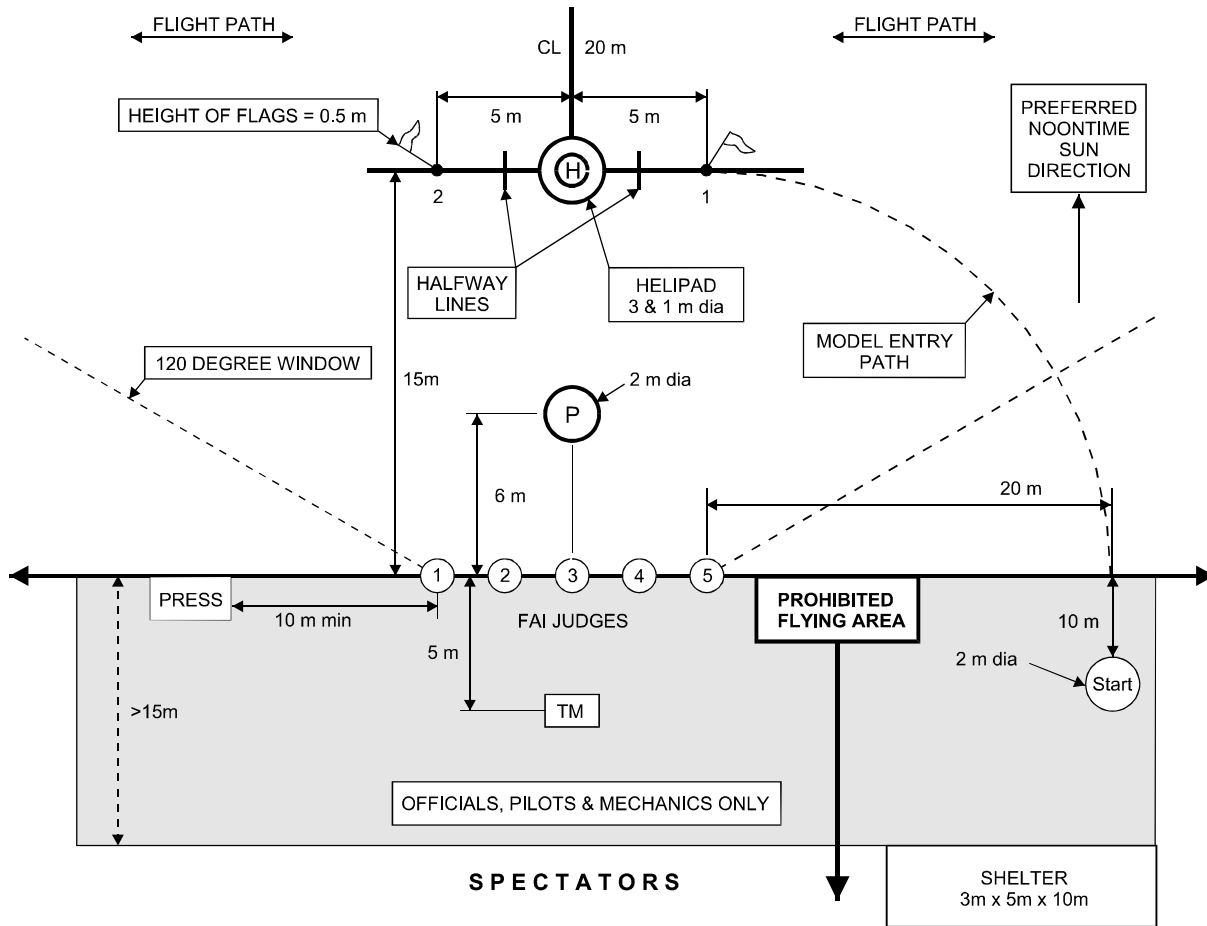

Marking the 120° sector for the pilot with flags

ANNEX 5D**F3C MANOEUVRE DESCRIPTIONS AND DIAGRAMS**

The manoeuvre schedules are listed below with the starting and ending direction (UU = Upwind - Upwind; DD = Downwind - Downwind; DU = Downwind - Upwind; UD = Upwind - Downwind) of each manoeuvre, relative to the wind, as indicated. The competitor has 9 minutes to complete the P schedule and 8 minutes to complete the SF and the F schedule. Schedule P will be flown for the preliminary rounds 1 through 4. Schedule SF/F will be flown for the semi final and final rounds.

SCHEDULE P

P1. VORTEX	(UU)
P2. DIAMOND 4	(UU)
(FLY BY)	
P3. DOUBLE CANDLE WITH DESCENDING FLIP	(DD)
P4. LOOP WITH 540° TAIL TURNS	(UU)
P5. UX WITH PUSHED FLIPS.....	(DD)
P6. OVAL WITH HALF ROLLS AND FLIP	(UU)
P7. OPPOSITE HALF AND FULL INVERTED ROLL	(DD)
P8. INVERTED UMBRELLA.....	(UU)
(FLY BY)	
P9. 180° AUTOROTATION	(DU)

SCHEDULE SF/F

F1. VERTICAL HOURGLASS WITH PIROUETTES 90°/180°.....	(UU)
F2. LAID EIGHT WITH PIROUETTES.....	(UU)
(FLY BY)	
F3. CANDLE WITH 360° TAIL TURN AND 180° PUSHED FLIP.....	(UU)
F4. DOUBLE CANDLE WITH HALF FLIPS AND HALF ROLLS.....	(DD)
F5. DOUBLE STALL TURNS WITH HALF ROLLS AND FLIP	(UU)
F6. THREE OPPOSITE ROLLS.....	(DD)
F7. INVERTED UMBRELLA WITH HALF ROLLS	(UU)
(FLY BY)	
F8. AUTOROTATION WITH FLIP AND TWO 90° TURNS	(DU)

5D.1 General

The manoeuvres are displayed in pictorial form in Figures 5D-P and 5D-SF/F for the case where the wind direction is left to right. The following descriptions apply to all manoeuvres and if not performed properly must result in downgrades. Points will also be subtracted if a manoeuvre is not performed as described. The starting/ending altitude for the hovering manoeuvres is 2m above the helipad. If a manoeuvre is unrecognisable it must be severely downgraded. If pirouettes are performed in the wrong direction, the score shall be zero (0) points. Ascents from, and descents to, the helipad must be vertical. Landings must be smooth and centred on the helipad. During the hovering manoeuvres all stops must be of 2 seconds minimum duration (unless specified otherwise). Circular and linear hovering segments must be performed at a constant speed. Every pirouette must be performed at a constant turning rate. The hovering manoeuvres must be started with the nose of the model aircraft (MA) facing left or right and must be flown as a unit (the starting heading must be same for each hovering manoeuvre). The competitor must stand in the 2m diameter circle marked "P" in Figure 5.4.A during all manoeuvres. All aerobatic manoeuvres must start and end in the direction indicated with a straight and level flight line of 10m minimum length. Entry and exit must be at the same altitude and heading. Loops or parts of a loop must be round and have the same diameter. Consecutive loops must be in the same location and plane. Rolls must be performed at a constant roll rate. Consecutive rolls must have the same roll rate and must be at the same altitude and heading. During all aerobatics manoeuvres the competitor must maintain his MA above a minimum altitude of 10 m. Aerobatic manoeuvres must be centred within the 120° horizontal field of view and must be symmetrical about the centre line. Aerobatic manoeuvres flown at a distance greater than 100m from the judges' line will be downgraded. In case of a dispute the manoeuvre text takes precedence over Figures 5D-P and 5D-SF/F.

Note: When the word “centred” is used, it means that the MA crosses an imaginary plane that extends from a line drawn vertically upward, from the centre judge out through the helipad. This refers to both Schedules P and SF/F.

Scoring criteria for landing; See ANNEX 5E paragraph 5E.6.11.

5D.2 SCHEDULE P

P1: Vortex (UU)

K=1.5

MA takes off vertically from the helipad and ascends to 2 m and hovers for a minimum of 2 seconds, ascends flying backwards describing the upper left (right) quarter of a circle with 5 m radius while simultaneously performing a 180° pirouette in any direction and stops over flag 1 (2), hovers for a minimum of 2 seconds and then hovers to the other flag 2 (1) while simultaneously performing two 180° pirouettes that are in opposite direction, stops and hovers over the flag 2 (1) for at least 2 seconds, descends forward describing the upper right (left) quarter of a circle with 5 m radius while simultaneously performing a 180° pirouette in any direction, stops over the center line for at least 2 seconds, descends and lands into the helipad.

P2: Diamond 4 (UU)

K=1.5

MA takes off vertically from the helipad and ascends to 2 m while performing simultaneously a 90° pirouette in any direction. It hovers there for at least 2 seconds, ascends 2.5 m in a straight line to any flag while performing a 180° pirouette in any direction and stops for at least 2 seconds. MA ascends 2.5 m in a straight line to 7 m above the center line while performing a 180° pirouette in any direction and stops for at least 2 seconds. MA descends 2.5 m in a straight line to the second flag while performing a 180° pirouette in any direction and stops for at least 2 seconds. MA descends 2.5 m in a straight line to 2 m above the center line while performing a 180° pirouette in any direction and stops for at least 2 seconds. MA descends and lands into the helipad while simultaneously performing a 90° pirouette in opposite direction of the first pirouette.

P3: Double candle with descending flip (DD)

K=1.0

MA flies straight and level for a minimum of 10 m and pulls up into a vertical ascent. After a nose up stop MA flies backwards vertically for 2m minimum performs a half pulled travelling flip, descends vertically for a minimum of 2m, performs a centred half loop and ascends vertically. After a nose up stop MA flies backwards vertically for 2m minimum, performs a half pulled travelling flip, descends vertically for 2m minimum and then pulls into horizontal straight and level flight for a minimum of 10m.

Note 1: The 2 flips must be made at the same altitude.

Note 2: The bottom of the half loop must be at the same altitude as when entering the figure.

P4: Loop with 540° Tail Turns (UU)

K=1.0

MA flies straight and level for a minimum of 10 m and performs 1 ¼ loop starting from the center line. When reaching half of the height of the former loop MA performs a 540° tail turn in any direction followed by a half loop in opposite direction. When reaching again half of the height of the first loop MA performs a second 540° tail turn in any direction. After MA pulls with quarter loop into horizontal straight and level flight for a minimum of 10 m at the same altitude as when entering the figure.

Note: The tail turns must be executed exactly at half the height of the loop with the MA being precisely vertical.

P5: UX with Pushed Flips (DD)

K=1.0

MA flies straight and level for a minimum of 10 m and pulls up into a 45° ascent with a centered half roll in any direction. Once the MA has come to a stop, MA performs a 225° pushed flip, performs a centered 'U', stops, performs a 225° pushed flip, performs a 45° descent with a centered half roll in any direction. MA pulls into horizontal straight and level flight for a minimum of 10 m.

Note 1: The bottom of the 'U' and the rolls must be centered.

Note 2: The bottom of the 'U' must be at the same altitude as when entering the figure.

P6: Oval with ½ Rolls and Flip (UU)

K=1.0

MA flies straight and level for a minimum of 10 m and pulls up into a half loop followed by a half roll in any direction, followed by a travelling 360° centered pulled flip and followed by a second half roll in any direction. MA then performs a half positive loop and pulls into horizontal straight and level flight for a minimum of 10 m at the same altitude as when entering the figure.

Note 1: If there is a straight line before the first half roll, there must be the same straight line after the second half roll.

Note 2: If there is a straight line after the first half roll, there must be the same straight line before the second half roll.

P7: Opposite half and full inverted rolls (DD)

K=1.0

MA flies straight and level for a minimum of 10m and performs a half roll in either direction, flies inverted for a minimum of 1 second, performs a full centred inverted roll in the opposite direction, flies inverted for a minimum of 1 second, performs a half roll in the same direction as the first half roll. MA flies straight and level flight for a minimum of 10m.

Note 1: The middle of the manoeuvre must be centred.

Note 2: There is one point deduction per inverted flight section that does not last in minimum 1 second.

P8: Inverted Umbrella (UU)

K=1.0

MA flies straight and level for a minimum of 10 m and pulls up into a vertical ascent at center line. After a nose up stop MA performs a half backward loop. After MA stops it performs a centered 'U'. After a nose up stop MA performs a second half backward loop. After a nose down stop MA descends forward vertically on center line followed by a quarter loop and exit after a 10 m straight line at the same altitude as when entering the figure.

Note 1: The quarter loops at the entrance and the exit of the figure and the half loop of the centered 'U' must have the same radius.

Note 2: The two half backward loops must be of equal size and must have half radius than the half loop of the centered 'U'.

Note 3: The bottom of the 'U' must be at the same altitude as when entering the figure.

P9: 180° Autorotation (DU)

K=1.0

MA flies straight and level for a minimum of 10 m at a minimum altitude of 20 m. Manoeuvre begins when model aircraft crosses an imaginary plane that extends vertically upward from a line drawn from the center judge out through the helipad. MA must be in the autorotation state when it cuts this plane, the engine must be off (or at idle) at this point and the MA must be descending. The 180° turn must start at this point and the turning and descending rate must be constant from this point to a point just before touchdown on the helipad. The flight path of the MA must appear as a semi-circle when viewed from above, starting at the vertical plane and ending at a line drawn from the center judge through the helipad. The MA's flight path must never be parallel to the ground or judge's line.

Scoring criteria for landing: See ANNEX 5E Paragraph 5E.6.11.

5D.3 SCHEDULE SF/F

F1: Vertical Hourglass with Pirouettes 90°/180° (UU)

K=1.5

MA takes off vertically from the helipad and ascends to 2 m, stops and hovers for a minimum of 2 seconds, flies backwards to flag 1 (2) while simultaneously performing a 90° nose in pirouette, stops and hovers for a minimum of 2 seconds. MA ascends sideways to 7 m over flag 2 (1) by a straight line while simultaneously performing two 180° pirouettes that are in opposite direction, stops and hovers for a minimum of 2 seconds. MA flies sideways horizontally back to flag 1 (2) while simultaneously performing two pirouettes 180° that are in opposite direction, stops and hovers for a minimum of 2 seconds. MA descends sideways to 2 m over flag 2 (1) by a straight line while simultaneously performing two 180° pirouettes that are in opposite direction, stops and hovers for a minimum of 2 seconds. MA flies sideways horizontally to the helipad while simultaneously performing a 90° pirouette in opposite direction as the first pirouette, stops and hovers for a minimum of 2 seconds. MA descends and lands into the helipad.

Note: The change of the pirouettes direction must be done smoothly on the center line.

F2: Laid Eight with Pirouettes (UU)

K=1.5

MA takes off vertically from the helipad and ascends to 4.5 m while performing simultaneously a 360° pirouette in any direction, then hovers there for at least two seconds. MA flies backwards and descends describing a vertical circle with a radius of 2.5 m while simultaneously performing a 360° pirouette in any direction.

MA flies forward and descends describing a vertical circle with a radius of 2.5 m while simultaneously performing a 360° pirouette in the opposite direction, stops and hovers for at least two seconds over the helipad. MA descends and lands into the helipad while simultaneously performing a 360° pirouette in any direction.

Note: The change of direction of the pirouettes must occur smoothly on the center line.

F3: Candle with 360° Tail Turn and 180° pushed Flip (UU)

K=1.0

MA flies straight and level for a minimum of 10 m and pulls up into vertical ascent on center line by doing a quarter loop. MA then performs a 360° tail turn, descends minimum 2 m vertically backwards and performs a 180° pushed flip while descending vertically. MA descends minimum 2 m vertically forward, pulls with a quarter loop into horizontal straight and level flight for a minimum of 10 m at the same altitude as when entering the figure.

Note 1: The quarter loops at the entrance and the exit of the figure must have the same radius.

Note 2: The vertical lines before and after the 180° flip must be of equal length.

F4: Double Candle with ½ Flips and ½ Rolls (DD)

K=1.0

MA flies straight and level for a minimum of 10 m and performs after crossing the center line a quarter loop and pulls up into a vertical ascent. At the end of the vertical ascent MA performs a 180° pushed flip followed by a recognizable distance of a vertical nose down descend followed by a half roll in any direction. MA performs a half inside loop and pulls up into a vertical ascent. At the end of the vertical ascent MA performs a 180° pulled flip followed by a recognizable distance of a vertical nose down descend followed by a half roll in any direction. MA performs a quarter inside loop which must end at the center line and exit after a 10 m straight line at the same altitude as when entering the figure.

Note 1: The 180° flips and the half rolls must be on the same altitude.

Note 2: The vertical lines before the half rolls must be of equal length.

F5: Double Stall Turns with half Rolls and Flip (UU)

K=1.0

MA flies straight and level for a minimum of 10 m and pulls up into vertical ascent on center line by doing a quarter loop. At the end of the ascent MA performs a 180° stall turn followed by a half roll in any direction. MA performs a ¾ inside loop followed by a travelling 360° centered pushed flip and another ¾ inside loop. MA ascends vertically and performs a second 180° stall turn at the end of the ascent followed by a half roll in any direction. MA pulls with a quarter looping into horizontal straight and level flight for a minimum of 10 m at the same altitude as when entering the figure.

Note 1: Before and after the half rolls straight vertical lines are allowed, but they must all be of equal length.

Note 2: Before and after the 360° flip straight horizontal lines are allowed, but they must all be of equal length..

F6: Three opposite Rolls (DD)

K=1.0

MA flies straight and level for a minimum of 10 m, performs a roll in any direction followed by a roll in opposite direction followed by a roll in the same direction as the first roll. MA flies straight and level for a minimum of 10 m.

Note 1: During the second roll the MA must be in inverted flight when it crosses the center line.

Note 2: The rolls must be executed one immediately after the other, straight flights between the rolls will be downgraded by one to two points.

Note 3: The elapsed time from the beginning of the first to the end of the third roll must be at least 4 seconds.

F7: Inverted Umbrella with half Rolls (UU)

K=1.0

MA flies straight and level for a minimum of 10 m and pulls up into a vertical ascent on center line. After a nose up stop MA performs immediately in a backward vertically flight a half roll in any direction followed by a half backward loop. After MA stops it performs a centered 'U'. After a nose up stop MA performs a half backward loop followed by a backwards vertically ascent. After a nose down stop MA performs immediately in a forward vertically flight a half roll in any direction followed by a vertical descent. MA pulls with a quarter looping into horizontal straight and level flight for a minimum of 10 m at the same altitude as when entering the figure.

Note 1: The quarter loops at the entrance and the exit of the figure and the half loop of the centered 'U' must have the same radius.

Note 2: The two half backward loops must be of equal size and must have half radius than the half loop of the centered 'U'.

Note 3: The bottom of the 'U' must be at the same altitude as when entering the figure.

Note 4: The two rolls must be performed at the same altitude.

F8: Autorotation with Flip and two 90° Turns (DU)

K=1.0

MA flies straight and level flight for a minimum of 10 m performs a pulled 360° flip in horizontal movement, flies horizontal straight and level for a maximum of 10 m and turns off the engine (or at idle) during this straight flight period, just before reaching the center line. MA executes 3 constantly descending sides with two 90° turns in the direction of the pilot and lands against the wind into the helipad.

Note 1: The descent rate must be constant to a point just before touchdown on the helipad.

Note 2: Parts of the second side, the second 90° turn and the beginning of the third side may be flown out of the 60° flight window.

Scoring criteria for landing: See ANNEX 5E Paragraph 5E.6.11.

Note: Manoeuvre diagrams are overleaf.

FIGURE 5D-P: F3C MANOEUVRE SCHEDULE P

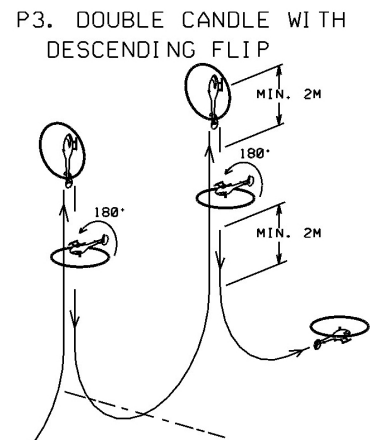
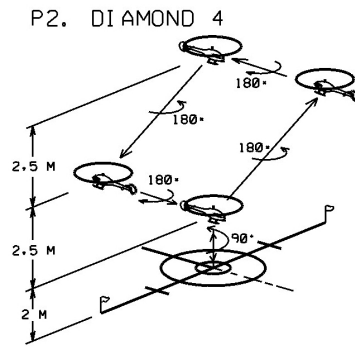
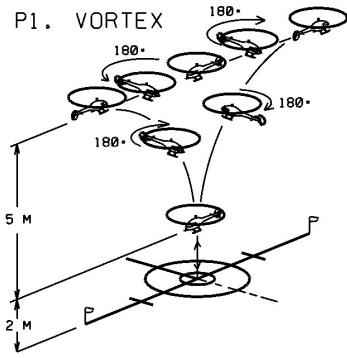

P4. LOOP WITH 540° TAIL TURNS

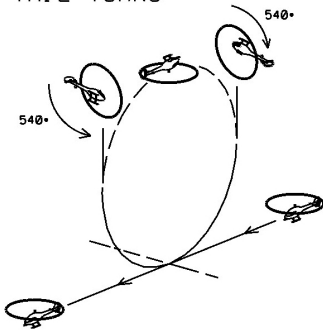

P5. UX WITH PUSHED FLIPS

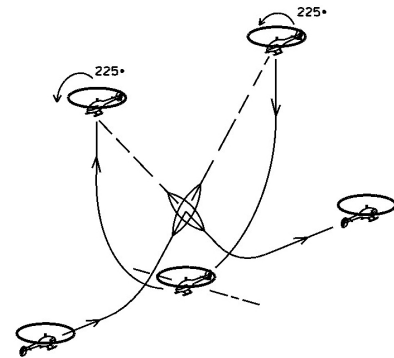

P6. OVAL WITH HALF ROLLS AND FLIP

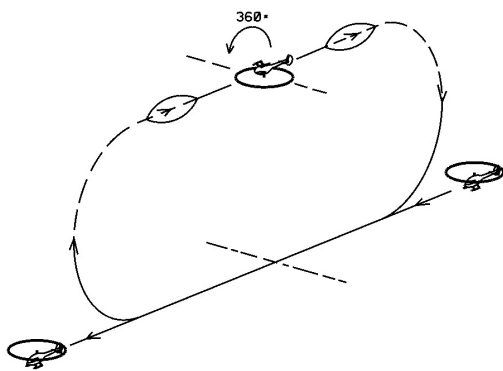

P7. OPPOSITE HALF AND FULL INVERTED ROLLS

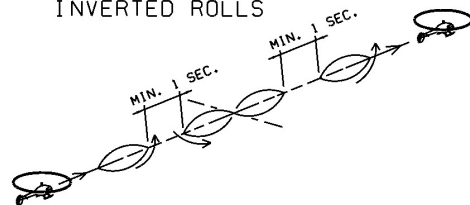

P8. INVERTED UMBRELLA

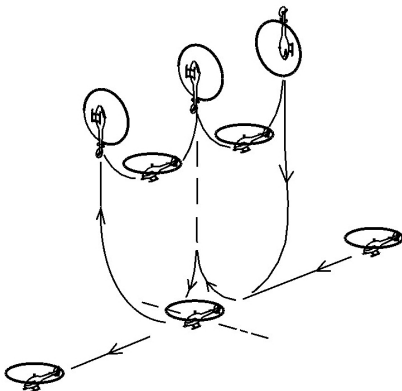

P9. 180° AUTOROTATION

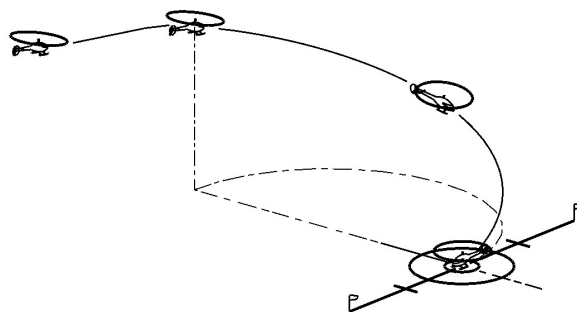
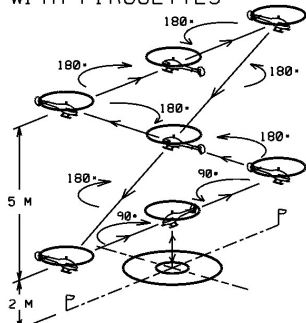

FIGURE 5D-SF/F: F3C MANOEUVRE SCHEDULE SF/F



F1. VERTICAL HOURGLASS WITH PIRQUETTES



F2. LAID EIGHT WITH PIRQUETTES

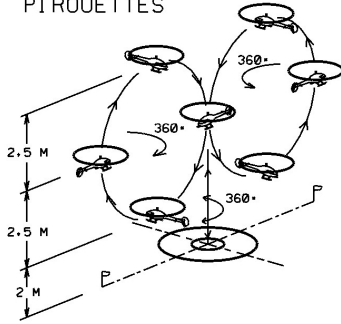

F3. CANDLE WITH 360° TAIL TURN AND 180° PUSHED FLIP

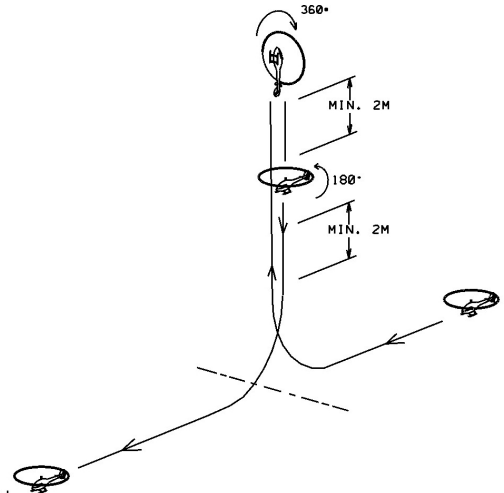

F4. DOUBLE CANDLE WITH HALF FLIPS AND HALF ROLLS

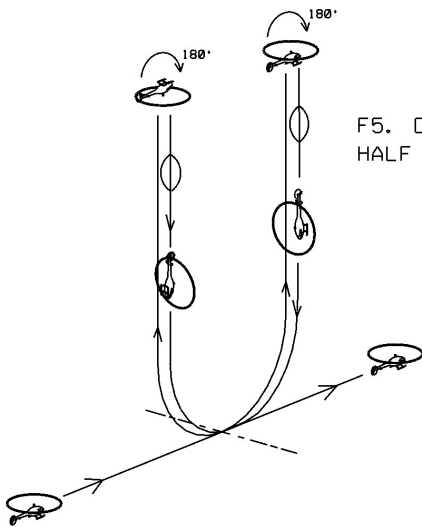

F5. DOUBLE STALL TURNS WITH HALF ROLLS AND FLIP

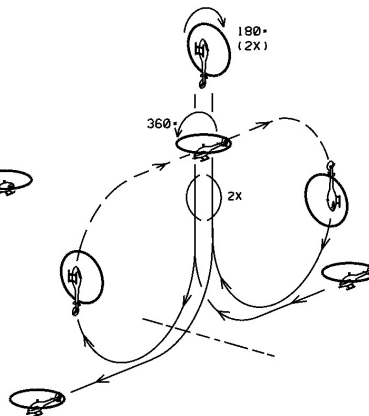

F6. THREE OPPOSITE ROLLS

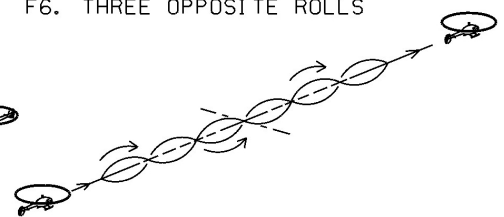

F7. INVERTED UMBRELLA WITH HALF ROLLS

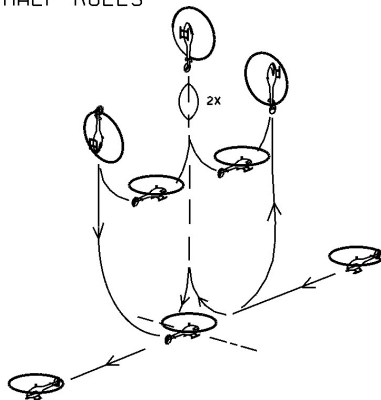

F8. AUTOROTATION WITH FLIP AND TWO 90° TURNS

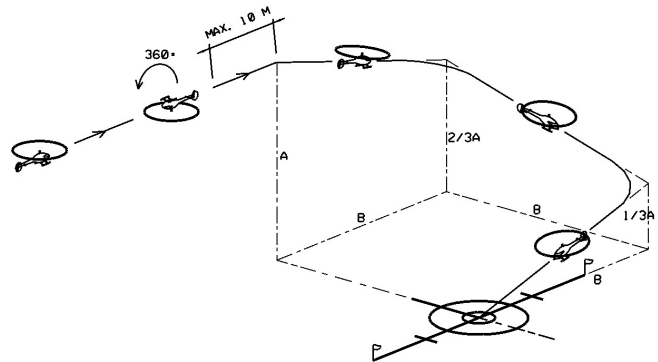

ANNEX 5E

F3C JUDGES' GUIDE

5E.1 PURPOSE

The purpose of the F3C Judges' Guide is to provide an accurate description of the major judging criteria to serve as a reference for use in developing a uniformly high standard of judging.

5E.2 PRINCIPLES

The principles of judging a radio controlled model helicopter should be based on the perfection with which the MA performs each manoeuvre as described in Annex 5D.

The main principles used to judge the degree of perfection are:

- 1) Precision of the manoeuvre.
- 2) Smoothness and gracefulness of the manoeuvre.
- 3) Positioning or display of the manoeuvre.
- 4) Size of the manoeuvres relative to each other.

The requirements are listed in order of importance; however, all of them must be met for a manoeuvre to receive a high score.

5E.3 ACCURATE AND CONSISTENT JUDGING

The most important aspect of judging is consistency. Each judge must establish his standard and then maintain that standard throughout the competition. It is recommended that the contest director or organiser hold a conference prior to the start of competition to discuss judging so that the standards are as uniform as possible. This can be accomplished with demonstration flights that all judges score simultaneously and privately. After these flights, the defects in each manoeuvre should be discussed by all judges and agreement reached about the severity of the defects. After the competition is started, the individual judges should not alter their standard. Judging accuracy is also very important. Being consistent, whether high or low is not sufficient if the scores awarded do not fairly reflect the performed manoeuvre.

5E.4 CRITERIA FOR JUDGING MANOEUVRES

A description of each manoeuvre is provided in Annex 5D. Each manoeuvre should be downgraded according to:

- 1) The type of defect.
- 2) The severity of the defect.
- 3) The number of times a defect occurs.
- 4) The positioning of the manoeuvre.
- 5) The size of the manoeuvre relative to other manoeuvres.

A high score should be given only if no major defects are noted and the manoeuvre is accurately positioned. Whenever there is doubt a lower score should be given.

5E.5 ATTITUDE AND FLIGHT PATH

The flight path of the MA is the trajectory of its centre of gravity. The attitude is the direction of the fuselage (canopy, boom, etc) centreline in relation to the flight path. All judging should be based on flight path, but the angle between the flight path and the longitudinal axis should never exceed 10°.

5E.6 GRADING CRITERIA FOR MANOEUVRE SEGMENTS

The following criteria are furnished to provide the judge with a guide for downgrading deviations from the defined manoeuvre segments. The segments are: Takeoffs, Landings, Stops, Lines, Pirouettes, Loops, Rolls, Stall turns and Flips.

5E.6.1. TAKEOFFS

Takeoffs for the hovering manoeuvres must start from the centre of the 1m circle to obtain maximum score. Takeoffs must be smooth and the MA must ascend vertically until the skids or landing gear are at 2m over helipad. Non-vertical ascents where the MA moves forward or backward by half a fuselage length result in a downgrade of 1 point.

5E.6.2. LANDINGS

Landings for the hovering manoeuvres must be centred in the 1m circle of the helipad to obtain a maximum score. If a portion of the skids or landing gear is outside of the 1m circle (but rotor shaft points to the inside of the 1m circle when viewed from above), the downgrade is one point. A landing outside of the 1m circle (rotor shaft points to the outside of the 1m circle when viewed from above) results in a downgrade of 2 points. Non-vertical descents where the MA moves forward or backward by half a fuselage length result in a downgrade of 1 point.

5E.6.3 STOPS

For the hovering manoeuvres the stops must be equal to or greater than 2 seconds in duration if not otherwise specified. All stops must be of the same duration. If a stop is less than 2 seconds long, a downgrade of half a point should be made. If a stop is greater than 2 seconds, no downgrade should result as long as the MA does not move. In manoeuvres containing stops of unspecified duration (but are a necessary part of the manoeuvre) no downgrade shall be made for the stops.

5E.6.4. LINES

For the hovering manoeuvres the lengths of the lines are defined by the 10m distance between flags 1 and 2 and must be straight. Diagonal lines must be performed at the proper angle. However, the aerobatic manoeuvres must be started and ended by equal horizontal lines of minimum length 10 m. A greater length of a vertical or climbing line, resulting from the performance of the MA, must not be allowed to positively influence a judge's score. One point should be subtracted for a recognisable difference. If there is a complete absence of a line, before or after a manoeuvre, 2 points should be subtracted.

5E.6.5. PIROUETTES

All pirouettes must be performed around the vertical axis. If the deviation is greater than 20° one point will be subtracted. During a hovering pirouette (stationary tail rotor turn), if the MA moves vertically or laterally by a noticeable amount, 1 point should be subtracted. If the vertical or lateral movement of the helicopter is significant (more than 25cm), 2 or more points should be subtracted. During an ascending pirouette, if the MA moves laterally by a noticeable amount, 1 point should be subtracted. If the MA's movement is greater than 25cm, 2 or more points should be subtracted. Travelling pirouettes must be synchronised with flight path. If the pirouettes are performed in the same direction for manoeuvres where pirouettes of opposite direction are prescribed, the score must be zero.

5E.6.6. LOOPS

A loop must, by definition, have a constant radius, and must be flown in a vertical plane. It starts and ends with a well-defined line, which for a complete loop will be horizontal. Every loop must be flown without segmentation. Every clearly seen segment should result in a downgrade of 1 point. If a loop is not flown entirely in a vertical plane, a minor drift should be downgraded by 1 point, while a more severe drift should be downgraded by several points.

5E.6.7. ROLLS

The roll rate must be constant. Small variations in roll rate should be downgraded by 1 point while more severe variations receive larger downgrades. Rolls (including partial rolls) must have crisp and well-defined starts and stops. If a start or stop is badly defined, 1 point is subtracted for each. Duration of the rolls must meet the minimum times specified.

5E.6.8. TAIL TURNS

The tail turns must be symmetrical by performing half of the rotation before and after the top. The tail turn must be around the main rotor shaft. If there is significant horizontal displacement, 1 point should be subtracted. The entry and exit must consist of partial loops with constant and equal radii.

5E.6.9 STALL TURN

The lines during this segment must describe vertical and horizontal flight paths. The model aircraft must come to a complete stop before a tail rotor turn is initiated. The tail rotor turn must be around the main rotor shaft. If there is significant horizontal displacement, one point should be subtracted. If the model aircraft shows a pendulum movement after the rotation, this should result in a downgrade of one point. The entry and exit must consist of partial loops with constant and equal radii.

cont/...

5E.6.10. FLIPS

Flips are stationary or travelling rotations about the lateral (elevator) axis of the MA. The direction of the flip is described according to the movement of the (elevator/longitudinal cyclic) control stick (Push = Negative - Nose down, Pull = Positive - Nose up). For the case of a stationary flip, one point should be subtracted if the MA moves forward or backward more than a fuselage length. For the case of a travelling flip, one point should be subtracted for a deviation of more than a fuselage length from the path of the described manoeuvre.

5E.6.11. AUTOROTATIONS

The manoeuvre begins and ends as announced by the caller. The end must be after the landing. Because the autorotation can contain several flying manoeuvres, the announced beginning can be before the engine is powered off or set to idle. The manoeuvre description must clearly state, when the engine has to be powered off or set to idle position. In order to obtain the maximum score, the MA must have executed the flying manoeuvres exactly as described in the manoeuvre description, and after the smooth landing the MA tailboom must be parallel to the judges' line. If the flight path is stretched, shortened or deviated from, in order to reach the landing circle, the manoeuvre must be downgraded. The required flight path gives maximum score, but there will be downgrades of 1 or 2 points depending of the severity of the path deviation. For example: If the flight path clearly points to a landing close to one of the flags, but the path is stretched to reach the circle, the score can only be a maximum of 6 (corresponding to outside the circles), and there will be an additional downgrade of 2 points for the stretch. This means the score can only be a maximum of 4. If the model lands without stretching, the maximum score would have been a 6.

Scoring criteria for Autorotation landings:

Landing gear inside 1m circle = Maximum 10 points.

Rotor shaft points to inside of 1m circle = Maximum 9 points.

Landing gear inside 3m circle = Maximum 8 points.

Rotor shaft points to inside of 3m circle = Maximum 7 points.

Rotor shaft points to outside of 3m circle = Maximum 6 points.

Note: If a flying manoeuvre is missed out or if the engine is not powered off (or not set to idle position), the score for the complete figure shall be zero.

5E.7 WIND CORRECTION

All manoeuvres are required to be wind corrected in such a way that the shape of the manoeuvre as described in Annex 5D is preserved in the MA's flight path.

5E.8 POSITIONING

All aerobatic manoeuvres must be performed within the 60° vertical and 120° horizontal viewing angle. Manoeuvres that are flown off centre will be downgraded according to the displacement. The downgrade may be in the range of 1 to 4 points. If a portion of a manoeuvre is flown outside of this air space a severe downgrade will occur. If the entire manoeuvre including entry and exit is flown outside of the window it must be scored zero points. Flying so far out as to make the evaluation of a manoeuvre difficult should also be severely downgraded. The main criterion here is visibility. Manoeuvres performed on a line further out than 100m away but in front of the judges should be downgraded in any case because even the keenest eye begins to lose perspective at that distance.

5.11 CLASS F3N – RC FREESTYLE AEROBATIC HELICOPTERS

5.11.1 Definition of a Radio Controlled Model Helicopter

A Radio Controlled (R/C) model helicopter is a heavier-than-air Model Aircraft (MA) that derives all of its lift and horizontal propulsion from a power driven rotor system(s) rotating about a nominally vertical axis (or axes). Fixed horizontal supporting surfaces up to 4 percent of the swept area of the lifting rotor(s) are permitted. A fixed or controllable horizontal stabiliser of up to 2% of the swept area of the lifting rotor(s) is permitted. Ground effect machines (hovercraft), convertiplanes or aircraft that hover by means of propeller slipstream(s) deflected downward are not considered to be helicopters.

5.11.2 General Characteristics

The swept area of the lifting rotor is not limited. The engine displacement is not limited. The use of pre-programmed flight manoeuvres is forbidden.

Limitations are:

- a) **WEIGHT:** The weight of the MA (with fuel or with batteries) must not exceed 6,5 kg.
- b) **BATTERIES:** Electric motors are limited to a maximum no load voltage of 51 volts for the propulsion circuit.
- c) **ROTOR BLADES:** All-metal main or tail rotor blades are prohibited.

5.11.3 Contest Area Layout

Refer to Figure 5.11.A. The drawing shows the recommended layout, the shape and distances of which should be kept for safety reasons. The centreline must be clearly indicated 20m out from the helipad.

5.11.4 Number of Helpers

After leaving the start box, the pilot is allowed one helper. The helper may give information to the pilot during the flight.

5.11.5 Number of Model Aircraft

The number of MA is not limited.

5.11.6 The Official Flight

There are three different flight programs: Set Manoeuvre flight, Freestyle flight and Music Freestyle flight. Before the flight the pilot has to be officially called. The MA can be flown or be carried to the flying area. The flight time begins when the pilot or his helper gives a distinctive hand signal, and finishes with another distinctive hand signal.

5.11.7 Scoring

The number of judges is at least three, and no more than five. At least 20% but not more than 40% of the judges must not have judged at the previous World Championships.

In the Set Manoeuvre flight each manoeuvre is given a score between 0 and 20 points by each judge. A manoeuvre that is not completed or not flown according to the description shall be scored zero (0) points. If a manoeuvre is scored zero points all judges must agree. In the freestyle or music freestyle flights the scoring is done after the flight according to the scoring criteria.

In the Set Manoeuvre flights, only manoeuvres that are completed in the flight time of 8 minutes will receive a score. If the flight time for the Freestyle or Music Freestyle program is less than three or more than four minutes, there shall be a downgrade of 5% for the flight. A flight shorter than two or longer than five minutes shall be scored zero points.

Manoeuvres must be performed where they can be seen clearly by the judges. If a judge, for some reason beyond the control of the competitor, is not able to follow the model aircraft through the entire manoeuvre, he may put a "Not Observed" (N.O.) mark. In this case, his score will, for that particular manoeuvre, be set to the average score given by the other judges, rounded to the nearest whole point.

5.11.8 Classification

After the completion of every round, all scores will be normalised by awarding 1000 points to the highest scoring flight. The remaining scores are then normalised to a percentage in the ratio of actual score over the highest score of the round. The scores should be calculated to at least two decimal places and recorded (truncated) to two places after decimal point.

There shall be two rounds of Set Manoeuvre flights and one round each for Freestyle and Music Freestyle. However, the lowest score of each competitor will be the throwaway score. The other scores are added together and then divided by the number of counting preliminary rounds.

The result is the preliminary score. If only one round is possible then the classification will be based on that round.

After completion of the preliminary flights, the top 10 competitors are entitled to three fly-off flights, one Set Manoeuvre flight, one Freestyle and one Music Freestyle flight. The normalised results of the preliminary rounds for the top 10 pilots plus the three fly-off scores provide four normalised scores with the best three to count for the final individual classification.

At national and open international competitions the preliminary/fly-off system is not mandatory.

Ties will be broken by counting the throwaway score. If the tie still stands, a “sudden death” freestyle fly-off must take place until a decision is made.

The team classification for World and Continental Championships is established at the end of the competition (after the fly-off flights) by adding together the numerical final placings of the three team members using the full list of competitors unless there is a fourth member of the team (who must always be a junior) in which case it will be the three best placed members. Teams are ranked from the lowest numerical scores to the highest, with complete three-competitor teams ahead of two-competitor teams, which in turn are ranked ahead of one-competitor teams. In case of a tie, the best individual placing decides the team ranking. (Ref: *CIAM General Rules*, C.15.6.2 i))

5.11.9 Organisation

The flight order for the first Set Manoeuvre round will be determined by a random draw. The flight order for rounds two (Freestyle), three (Set Manoeuvre) and four (Music Freestyle) will start after the first, second and third quarter of the initial order. The flight order for the fly-offs will be determined in the same manner.

Preparation Time: A competitor must be called at least 5 minutes before he is required to enter the start box. The MA may be hovered only up to 2m in the start box. After the preceding competitor has finished his flight, the competitor is given another minute (two minutes in Freestyle) to make last minute adjustments or checks.

5.11.10 Flight Program

Safety During the Flights

The prohibited flying area (see figure 5.11.A) is observed by the judges. If the safety line is crossed the flight shall be scored zero points.

The competitor may choose his position during the flight with the following constraints:

- (a) The MA must not be flown between the pilot and judges.
- (b) The pilot must stand in front of the judges.

The non-observance of these constraints will be penalised by a zero score in the safety criterion for the manoeuvre or the flight in Freestyle.

If, during a flight in any of the schedules, a part of the helicopter except the landing gear or tail fin touches the ground the flight is terminated and scored zero points. This also applies to the MA tilting over after a landing or autorotation.

Set Manoeuvre Flight

Every pilot makes his choice of seven different manoeuvres from the list of manoeuvres (refer to paragraph 5.11.11). He may choose different manoeuvres for each round. The list with the manoeuvres chosen for a round must be delivered to the Contest Director or an official before the beginning of the round. The flight time of the Set Manoeuvre rounds is eight minutes.

Freestyle Flight

Each competitor is given a flight timeframe of at least three, and no more than four minutes. During this time there are no restrictions for the flight or the performed manoeuvres except those regarding safety. The play-back of music is not allowed. The flight time begins when the helper gives a distinctive hand signal and finishes only with another distinctive helper hand signal.

Music Freestyle Flight

The same criteria as in Freestyle, but the play-back of music during the flight is prescribed. The flight time begins when the helper gives a distinctive hand signal and finishes only with another distinctive helper hand signal. If the music starts before the flight, the flight time starts not later than 15 seconds after the start of the music.

5.11.11 Optional Manoeuvres

The Optional Manoeuvre list that is changed on a yearly basis after approval by CIAM Bureau will be available from the F3 Helicopter Subcommittee Chairman at the beginning of each year.

Note: It may not be possible to include in the F3 Helicopter volume of the Sporting Code the Optional Manoeuvres that are approved annually by Bureau at its December meeting.

The F3N Contest Area Layout appears below.

FIGURE 5.11.A – F3N CONTEST LAYOUT AREA

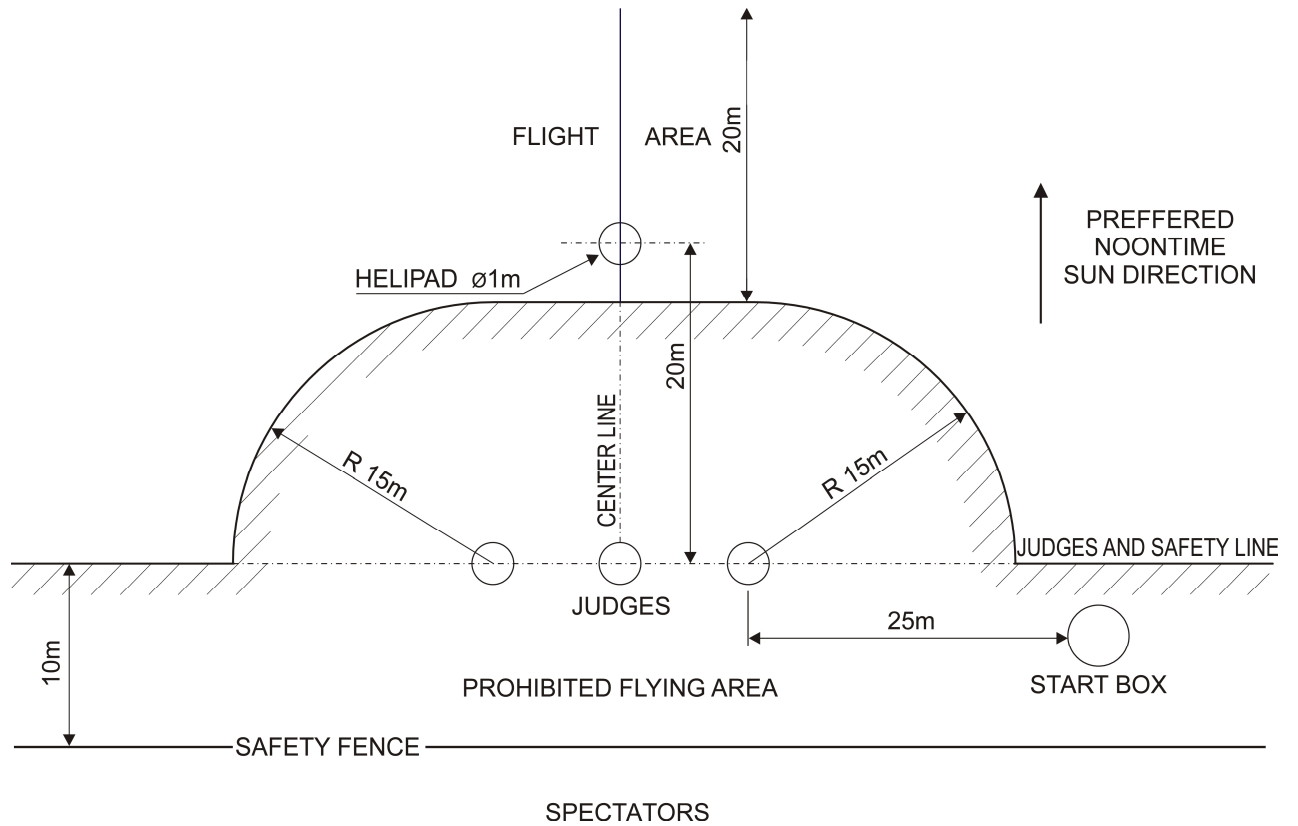

The manoeuvre descriptions appear on the next page.

ANNEX 5F

F3N MANOEUVRE DESCRIPTIONS AND DIAGRAMS

5F.1 F3N SET MANOEUVRE DESCRIPTIONS

- (a) The list of Set Manoeuvres contains 30 manoeuvres (listed below) and ten optional manoeuvres. The optional manoeuvres must be selected by the organiser at least 6 months prior to the competition from a list that is available from the F3 Helicopter Subcommittee Chairman. This list will be revised by the F3 Helicopter Subcommittee on a yearly basis and will be approved by the CIAM Bureau.
- (b) The competitor or his caller must announce the name and start and finish of each manoeuvre. All aerobatic manoeuvres start and end with a straight and level flight of 10 metres minimum length parallel to the judges' line. All manoeuvres from stationary flight start and end with a hovering of at least 1 second with the MA parallel or vertical to the flight line. All manoeuvres (considering also entry and exit) should be performed symmetrical to the centre line. The drawings in paragraph 5.11.12 illustrate the manoeuvres, in case of a dispute the following text takes precedence over the drawings. All manoeuvres can also be flown in opposite direction to that shown in the drawings.

Number	Description	K-Factor
1.1.	Double Immelmann MA performs a half inside loop immediately followed by a half roll to upright flight. After a straight flight of about 20 meters MA performs a half outside loop, again immediately followed by a half roll to upright flight.	K=4.0
1.2	Double roll backwards MA enters in upright backward flight and performs two consecutive axial rolls.	K=4.5
1.3	4-point roll MA enters in upright forward flight and then performs 4 quarter rolls, separated each by a recognizable straight segment of the same duration.	K=4.5
1.4	Outside loop with half rolls MA performs a half roll to inverted flight, followed by a recognizable straight segment and then enters an outside loop (upward). After the loop, MA flies another recognizable straight segment, followed by a half roll to upright flight.	K=5.0
1.5	Inverted horizontal eight MA enters in inverted forward flight parallel to the judges' line, performs a 90°-turn to a straight flight above the centre line and then performs a horizontal eight, consisting of two 360° circles. The manoeuvre is not intended as a hover manoeuvre. In case of low flying speed and banking angle less than 45deg, severe downgrade will apply.	K=6.0
1.6	Backward knife edge pirouette MA enters in upright backward flight, transitions to a slight ascent (max 15°) and performs a quarter roll. After a recognizable straight segment MA performs a 360°-pirouette, followed by another straight segment and a quarter roll in opposite direction to the first to upright backward flight.	K=5.5
1.7	Four pushed half flips MA hovers in upright position, then performs four half pushed flips (forward) each separated by a hovering of 2 seconds. MA maintains its position during the manoeuvre.	K=5.5
1.8	Tic-toc (Metronome) MA hovers and then is rotated (Nose up) about 135°. It then starts rotating alternately about the lateral axis by about 90° forward or backward. Both 45° positions have to be reached at least three times. The tail rotor stays almost in the same position during the manoeuvre.	K=6.0
1.9	360°-turn with roll MA enters in upright forward flight in the center of the window and then after a straight and level flight section performs a quarter (inside) loop to a vertical climb. Just before the stall, MA performs a 360°-pirouette to a vertical (backward) dive, followed by another quarter (inside) loop to upright flight and an axial backward roll centered on the main judge's line.	K=6.0

Note 1: The 1/4 input and output loop must be the same size.

Note 2: The exit must be at the same height as the entrance.

Note 3: Axial backward roll, must not have a straight line after 1/4 of loop and must be centered on the centreline of the window.

- 1.10 Standing 8** **K=8.0**
 MA enters in forward upright flight parallel to judge line. After passing centerline, MA performs half inside loop, followed by half outside loop. MA is now at the top of the standing 8 on the centerline, and performs fast half pirouette. MA now performs half outside backwards loop, followed by half inside backwards loop. MA is now back to starting point on centerline, and exits in backwards upright flight. All loop segments must have same radius.
- 1.11 Spike** **K=7.0**
 MA enters in upright forward flight. MA performs a 2-point half roll, followed by minimum 10m inverted flight. MA then performs 1/4 outside loop and ascends vertically. MA then descends vertically and performs 1/4 inside backwards loop with same radius as before, followed by minimum 10m upright backwards flight. MA then performs a 2-point half roll, and exits in backward inverted flight on the same line as the manoeuvre was started.
- 1.12 Inverted backwards horizontal eight** **K=7.0**
 MA enters in inverted backward flight parallel to the judges' line, performs a 90°-turn to a straight flight above the centre line and then performs a horizontal eight, consisting of two 360° circles with the tail always pointing in flight direction.
 The manoeuvre is not intended as a hover manoeuvre. In case of low flying speed and banking angle less than 45°, a severe downgrade will apply.
- 1.13 Rolling circle** **K=7.5**
 MA performs a horizontal circle while it performs consecutive axial rolls. MA speed, rolling rate and the radius of the circle should be constant.
- 1.14 4 rainbows with half rolls** **K=7.5**
 MA performs a rainbow (a semicircle with the lateral axis always vertical to the flight path) to a recognizable stop, then a stationary half roll to another stop. Then it enters another rainbow to a stop on the position of the start of the manoeuvre, followed by another half roll and continues like that, until four rainbows and four half rolls are completed.
- 1.15 Funnel** **K=7.5**
 MA enters in inverted flight and performs a quarter pirouette. MA then performs three superimposed circles in lateral inverted flight with the rotor disk tilt at least 45 degree from a horizontal plane. The diameter of the circles should be at least 10 meters.
- 1.16 Tumbling Circuit** **K=8.0**
 MA enters in backwards upright flight parallel to judge line. Before passing centerline MA performs 1/4 backward inside loop, which stops on the centerline. MA then completes a horizontal circle while doing sequence of half forward outside loops and half backward inside loops. Circle must include a minimum 4 of these sequences distributed equally. When passing centerline again, MA performs 1/4 forward outside loop, and exits in forward inverted flight on same line as manoeuvre was started.
- 1.17 Triple pirouetting flip** **K=7.5**
 MA hovers on centreline and then starts pirouetting. At the same time or after one pirouette the MA starts to flip three times while it continues to perform pirouettes continuously. There should be at least one pirouette during each 360° flip (2 pirouettes are shown only as an example in the drawing). MA finishes by stopping in the same hover position and orientation as the starting point. Pirouettes and rotations should have a constant rate.
- 1.18 Cuban eight backwards** **K=8.0**
 MA enters in upright backward flight and performs a 5/8 inside loop to a 45° downline. The MA performs a half roll centred on the downline, followed by a 3/4 inside loop and another half roll centred in the 45°downline. MA then finishes the first partial loop to upright backward flight. The tail of the MA should always point in the direction of flight.

cont/...

- 1.19 Pirouetting loop** **K=8.0**
 MA enters in upright flight and starts performing pirouettes when reaching the centreline. The MA then performs an inside loop while constantly performing pirouettes about the yaw axis. During the one loop there must be at least 2, but not more than 6 pirouettes. The pirouettes should be distributed equally through the loop and stop on centreline before exiting.
- 1.20 Backward rolling circle** **K=9.0**
 MA enters in upright backward flight and performs a horizontal circle while it performs consecutive axial rolls. MA speed, rolling rate and the radius of the circle should be constant. The tail of the MA should always point in the direction of flight. Rolling should start and stop on centreline. MA exits in backward upright flight.
- 1.21 Waltz** **K=8.5**
 MA enters in inverted flight and on centreline immediately performs a quarter pirouette, tail rotates to circle centre and enters a funnel. After a quarter funnel MA performs a complete smaller funnel (max. half diameter of the first) then continues with another quarter larger funnel, followed again by a complete smaller funnel etc. After the larger funnel is completed there is again a complete smaller funnel, followed immediately on centreline by another quarter pirouette to the exit in inverted flight. The diameter of the large funnel should be at least 20 meters.
- 1.22 Double 4-point Tic-toc** **K=8.0**
 MA hovers tail in on centreline and is then rotated nose up by pulled flip to approx. 135°. It then starts rotating alternately about the lateral axis for about 45° in each direction. Both 45°-positions have to be reached one time for one tic-toc. The MA then rotates by 90° on a clock face. It performs another tic-toc in this position, then again performs another 90° rotation and so on, until it has performed two complete rotations of a clock face while executing tic-tocs. The MA should describe a circular shape during the manoeuvre. The 90° rotations can be performed either when the model reaches one of the two end positions, or integrated in the movement back, before the next tic-toc is performed.
- 1.23 Pirouetting funnel** **K=8.5**
 MA enters in inverted flight and then starts pirouetting whereas it performs three superimposed circles in lateral inverted flight with the rotor disk tilt at least 45 degree from a horizontal plane. The diameter of the circles should be at least 10 meters and there should be at least three pirouettes during each circle. MA exits in inverted flight.
- 1.24 Four point tic-toc reversal** **K=9.0**
 MA hovers on centreline tail in and is then rotated nose up by pulled flip to 135°. It then starts rotating alternately about the lateral axis for about 45° in each direction. Both 45°-positions have to be reached one time for one tic-toc. The MA then rotates by 90° clockwise on a clock face. It performs another tictoc in this position, then again performs another 90° rotation and so on, until it has performed one complete rotation of a clock face while executing tic-tocs. The MA now immediately begins a full rotation in the opposite direction, following the same tic toc steps. The MA should describe a circular shape during the manoeuvre.
 The 90° rotations can be performed either when the model reaches one of the two end positions, or integrated in the movement back, before the next tic-toc is performed.
- 1.25 Pirouetting globe** **K=9.0**
 MA enters in upright flight and then performs four pirouetting loops. During each loop, the flight path is changed in a way, that the next loop is rotated about 45° (seen from above) until a complete globe has been described. The MA exits the manoeuvre at the same altitude but in opposite direction to the beginning. During each loop, the MA must perform at least two pirouettes. The pirouettes should be distributed equally through the loop.
- 1.26 Duus Iglo** **K=9.0**
 Viewed from above, the manoeuvre shows an X. The centre point of the X is on the centreline. MA enters in 1 of the 4 outer points in the X in upright hovering and boom pointing to centre of the X. Model then performs half pulled rainbow, while also doing an integrated half pirouette. Top of rainbow must be at the centre of the X. MA then makes a sharp quarter aileron roll, and completes second half of the rainbow while making another integrated half pirouette until model hovers inverted shortly. The boom still points to centre of the X, but now in another of the 4 outer points. *cont/...*

Same sequence is then repeated 3 more times, until MA is back at the starting point. Hovering will be inverted after the first and third legs.

- 1.27 Rolling Circle Tail Reversal** **K=9.5**
 MA enters in forward upright flight parallel to judge line. Immediately after passing centreline, MA starts a horizontal rolling circle. After each quarter of the circle, MA performs a half elevator flip. After each half flip the roll input direction must be changed. After a complete circle and the four half flips, MA exits in forward upright flight. Speed and height of MA should be constant during complete manoeuvre.
- 1.28 Funnel with half rolls** **K=9.5**
 MA enters in inverted flight and performs a quarter pirouette. MA then performs three superimposed circles in lateral inverted flight with the rotor disk tilt at least 45 degree from a horizontal plane. After each half funnel except the last the MA performs a half roll centred on the centreline. After three funnels and five half rolls the MA exits in upright flight. The diameter of the circles should be at least 10 metres.
- 1.29 Pirorainbow X reversal** **K=11.0**
 MA hovers over the centre line with an angle of 45°, then enters the manoeuvre with a rainbow, a not stationary flip that follows an arched flight path of at least 10 meters length. During the rainbow the MA performs one pirouette in each direction, with the reverse on the top of the rainbow. Then another rainbow (with pirouette reversal) leads back to the starting point. MA then continues with these rainbows rotating in 90° steps CW or CCW, until the four outer points of an X (viewed from above) are reached and MA hovers where it started the manoeuvre. MA does not perform any part of the pirouettes, when hovering in the centre. During the stops at the four outer points, rotor disk must be horizontal but there should be no hovering.
- 1.30 Vertical Tic Toc Eight** **K=10.5**
 Model enters in upright forward flight and performs a quarter roll to knife edge on centreline, MA then performs a half tic-toc loop. On the top of the loop MA performs a half pirouette, and then continues up with another half tic-toc loop while keeping the tail in the flight direction. On top of this second circle MA performs a half roll. It completes the upper tic-toc loop with the tail in the flight direction. It then performs another half pirouette and completes the lower tic-toc loop with the nose in the flight direction. Model exists in upright forward flight. During the manoeuvre the longitudinal axis of the model always follows the flight path.

The manoeuvre drawings appear on the next page.

5F.2 SET MANOEUVRE DRAWINGS

Set Manoeuvres 1 – 17 (of 30)

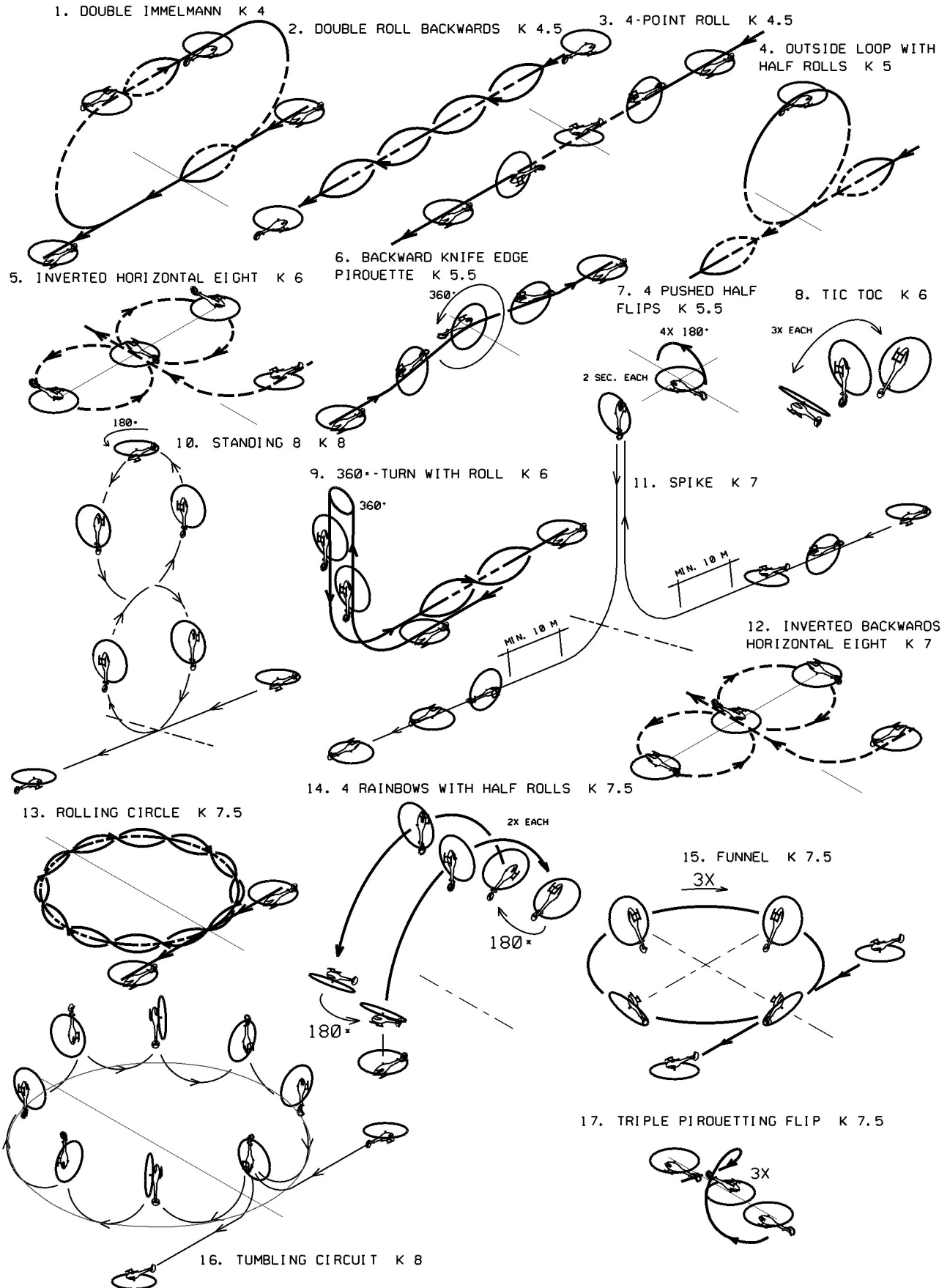

Set Manoeuvres 18 – 30.

18. CUBAN EIGHT BACKWARDS K 8

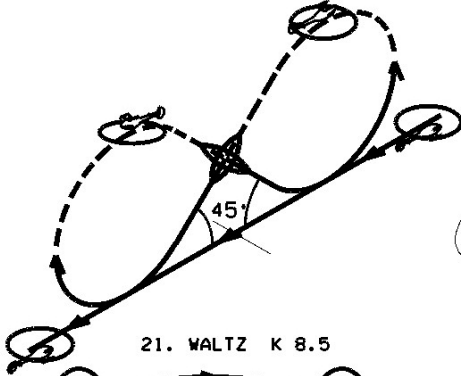

19. PIROUETTING LOOP K 8

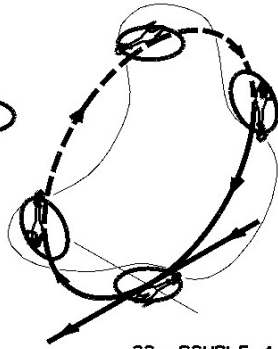

20. BACKWARD ROLLING CIRCLE K 9

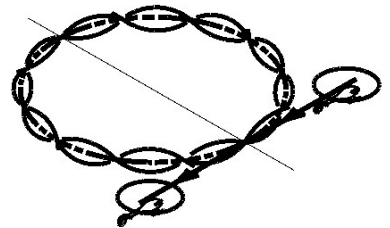

21. WALTZ K 8.5

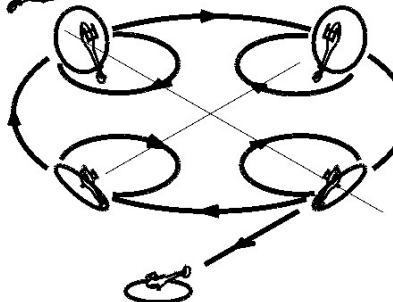

22. DOUBLE 4-POINT TIC TOC K 8



23. PIROUETTING FUNNEL K 8.5

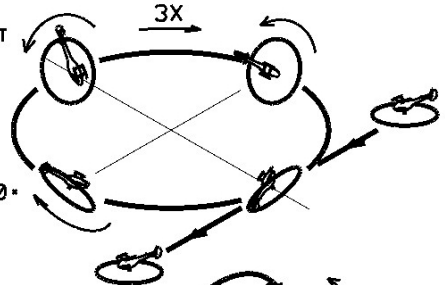

25. PIROUETTING GLOBE K 9

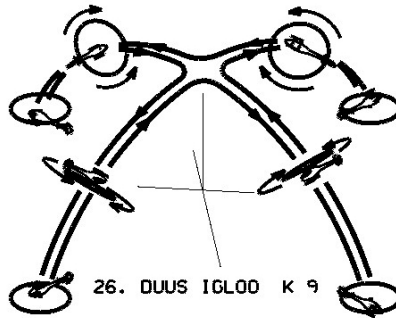
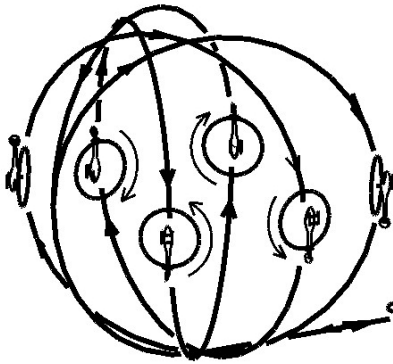

26. DUUS IGLOOD K 9



24. 4-POINT TIC TOC REVERSAL K 9

28. FUNNEL WITH HALF ROLLS K 9.5

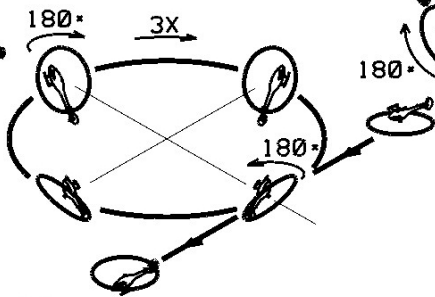

27. ROLLING CIRCLE TAIL REVERSAL K 9.5

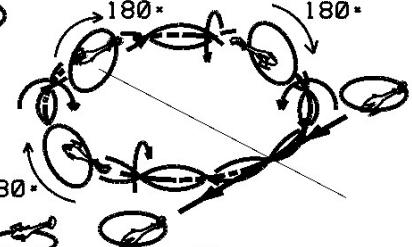

29. RAINBOW X REVERSAL K 11

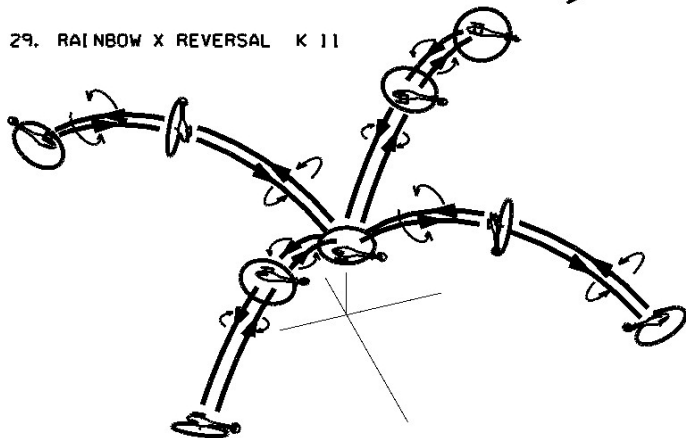

30. VERTICAL TIC TOC EIGHT K 10.5

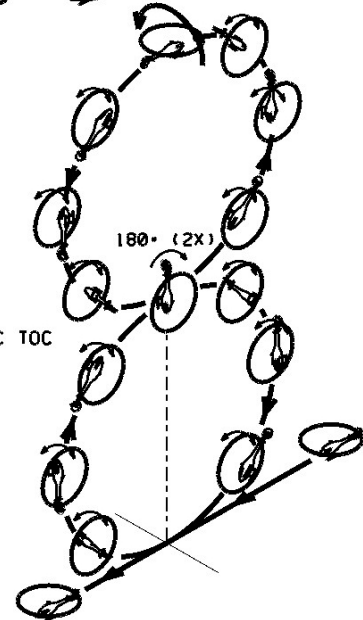

PAGE DELIBERATELY LEFT BLANK

5F.3 CLASS F3N OPTIONAL MANOEUVRE LIST

The Optional Manoeuvre list will be available from the F3 Helicopter Subcommittee Chairman at the beginning of each year.

The optional manoeuvres will be labelled B1 through B10.

Each year the optional manoeuvres will be modified or changed to adapt to the rapidly evolving F3N class. Organisers of F3N competitions must announce the use of a new list if appropriate at least 6 months prior to the event. The following will apply:

- For World or Continental Championships all optional manoeuvres must come from the annual list.
- For National Championships it is recommended that at least 5 manoeuvres should come from this list.
- For local competitions the organiser does not have to use manoeuvres from this list.

Number	Description	K-Factor
B.1	Rolling Globe reversal MA enters in upright flight and then performs four rolling loops. During each loop, the flight path is changed continually in a way that the low point is passed rotated about 45° (seen from above) until a complete globe has been described. After each loop the roll direction is changed. The MA exits the manoeuvre at same altitude as the entry, but in opposite direction. During each loop, the MA must perform at least 2 rolls with constant roll rate.	11.0
B.2	Double O One Twins MA enters in forward upright flight parallel to the flight line. Model performs ¼ of a loop. After the ¼ loop the boom is vertical, and model is on centre line. MA then performs one complete outside loop. During the first half of the loop, the model performs half pirouette, and during the second half of the loop, the model performs another half pirouette in opposite direction. MA is now back to same point on the centreline and with same orientation as when the complete loop started. Model now performs a complete inside loop, with pirouettes similar to the first complete loop. After second complete loop, MA performs ¼ roll, and it then repeats the above sequence with the 2 loops on the centreline. After 4 th loop, MA makes ¼ roll and exits via ¼ loop in backward flight to the same side and height as the entry came from. All loops must have same size and pirouettes same constant rate.	11.5
B.3	Time Travel MA hovers upright on the centreline nose in. MA then performs a pirouetting tic toc loop with skids out. The circular loop must consist of exactly 12 tic tocs. After each tic toc the boom must point to the centre of the loop. MA boom will change direction corresponding to 1 hour per tic toc. Each tic must include a half pirouette in one direction, and each toc must include a half pirouette in the opposite direction. MA completes the manoeuvre by stopping in the same orientation and location as the starting point.	10.5
B.4	3D Clock MA is hovering nose in on centreline. It then makes half pulled flip to skids in nose up vertical position. It then performs 12 tic tocs. After or during each tic toc, the tail rotates corresponding to 1 hour. Furthermore, the clock is rotating, so that skids are in at 12 o'clock, tail is in at 3 o'clock, rotor disc is in at 6 o'clock, and finally tail is in again at 9 o'clock. Model exits by returning to hover in same position and orientation as at the start of the manoeuvre.	11.5
B.5	Teacup Eyes MA starts with an upright hover and tail in on the centreline at a minimum of 10m height. It then performs a first pirouetting tic toc loop to either side parallel to the flight line with skids out. The loop must contain a minimum of 8 tic tocs, and each tic toc must clearly include more than 1 pirouette. After the loop, MA is back to the starting point and then immediately reverses the pirouette direction. There is no hovering after the first loop. It then performs a second piro tic toc loop with skids out to the other side of the centreline. After second loop MA stops in same hover position and orientation as the starting point. Loops should be of equal size with a similar number of tic tocs in each loop.	10.0

cont/...

- B.6 Cuban 8 with roll reversal** **11.0**
- MA enters in upright backward flight. When crossing the centre line it starts continuous rolls. While rolling, MA performs half Cuban 8 parallel to the flight line. Symmetrically around the centreline, MA stops rolls, performs half pushed elevator flip, and restarts rolling in opposite direction by changing the aileron input direction. MA is now in forward flight while rolling. MA then performs second half of the Cuban 8 while continuously rolling. Symmetrically around the centreline, MA stops rolls, performs half pushed elevator flip, and restarts rolling in the same direction as was used at the manoeuvre start. MA stops rolling and exits in upright backward flight.
- B.7 High Seas** **11.0**
- MA starts with an upright hover on the centreline with the boom parallel to the flight line. MA then starts a vertical climb while making a pulled quarter elevator flip on the centerline.
- Once complete it starts continuous rolls. While rolling it performs a backwards half loop to the right, and once completed immediately reverses to a forward rolling half loop back to the same upper height on the centreline.
- Now with the CG at standstill, roll direction is reversed and MA then performs two similar half loops to the left side, again rolling is stopped when CG is at standstill and MA is at the upper height on centre line.
- MA now descends vertically on the centreline while making a pushed quarter elevator flip returning to a hover in the initial starting orientation and position. Half loops should be equal in size with a similar number of rolls in each segment.
- B.8 Rough Diamond** **10.0**
- MA hovers on centreline with boom parallel to judgeline. It then performs 2 forward 360° tumbles while moving in a 45° up direction. MA makes ¼ right (left) pirouette to tail in orientation. It then performs 2 complete right (left) rolls in a 45° up direction, followed by another ¼ right (left) pirouette. MA is now at top of the diamond on the centreline. MA then performs 2 backward 360° tumbles while moving in a 45° down direction, followed by another ¼ right (left) pirouette to nose in orientation. Finally MA performs 2 complete right (left) rolls while moving in a 45° down direction, followed by a last ¼ right (left) pirouette. MA is now back to starting point and in same orientation. Hovering must only occur at start and exit of the manoeuvre.
- B.9 TicToc Loop** **10.0**
- MA hovers on centerline with nose pointing to the pilot. MA performs a ¼ pulled flip and starts with Tic Toc. MA performs a ¼ Tic Toc loop with skids pointing to the pilot. MA then performs a half roll in any direction so that the rotor disc points to the pilot and continues with the Tic Toc loop. On top of the loop MA performs a flip in any direction so that the skids point again to the pilot and continues with the Tic Toc loop. After ¾ of the loop MA performs again a half roll in any direction so that the rotor disc points again to the pilot and finishes the Tic Toc loop on centerline so that MA hovers again on centerline with nose pointing to the pilot.
- B.10 Pirouetting Waltz Reversal** **11.0**
- MA enters in inverted flight and then starts pirouetting whereas it performs different circles in lateral inverted flight with the rotor disk tilt at least 30 degree from a horizontal plane. After a quarter funnel MA performs a complete smaller pirouetting funnel (max. half diameter of the first) while pirouetting in the opposite direction then continues with another quarter larger pirouetting funnel in the same pirouetting direction as the first quarter, followed again by a complete smaller pirouetting funnel again in the opposite direction etc. After the larger pirouetting funnel is completed there is again a complete smaller pirouetting funnel, followed by the exit in inverted flight. The diameter of the large pirouetting funnel should be at least 20 meters.
- Pirouetting rate must be chosen, so that each ¼ of the large circle includes exactly 1 complete pirouette, and so that each of the small circles also includes exactly 1 pirouette.

The Optional Manoeuvre diagrams appear overleaf.

5F.4 Optional Manoeuvre Drawings

Optional Manoeuvres 1-5 (of 10)

B.1 ROLLING GLOBE REVERSAL

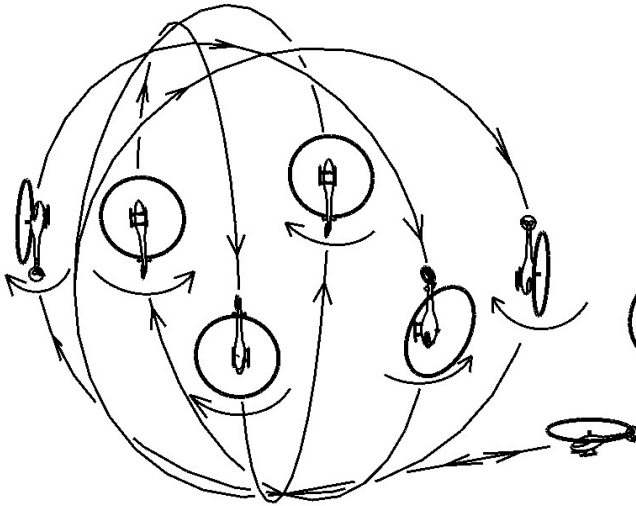

B.2 DOUBLE O ONE TWINS

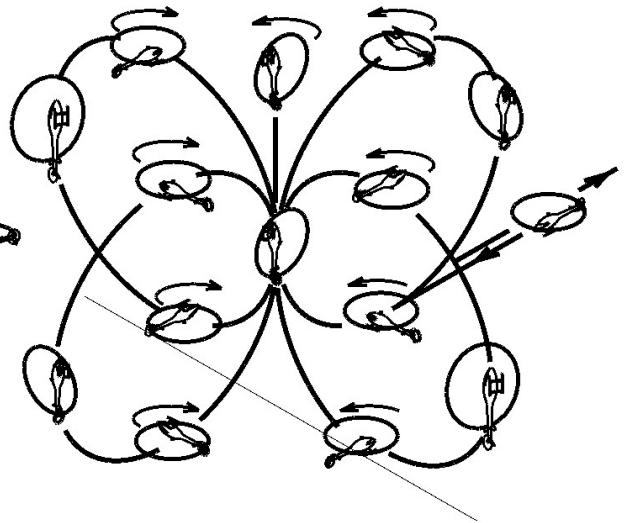

B.3 TIME TRAVEL

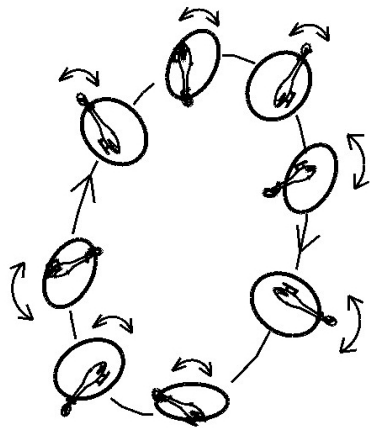

B.4 3D CLOCK

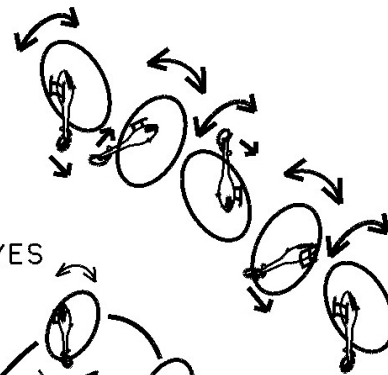

B.5 TEACUP EYES

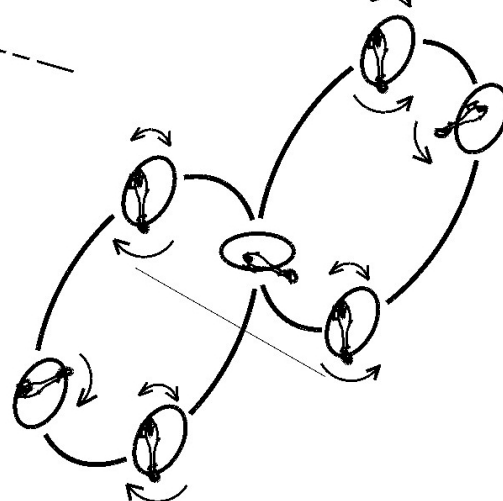

Optional Manoeuvres 6 -10



B.6 CUBAN EIGHT WITH ROLL REVERSAL

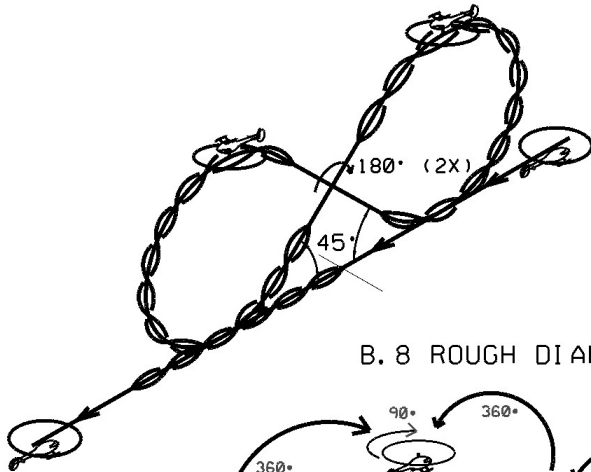

B.7 HIGH SEAS

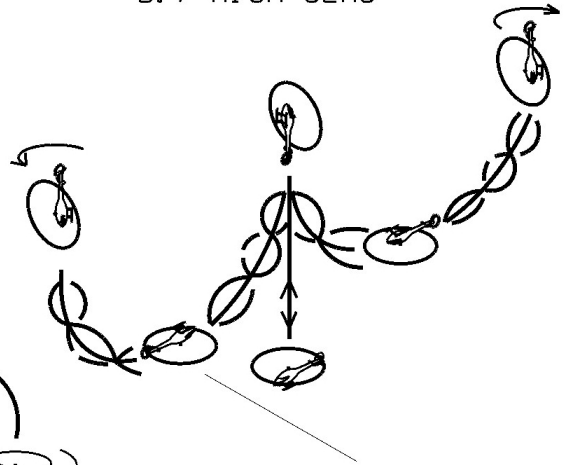

B.8 ROUGH DIAMOND

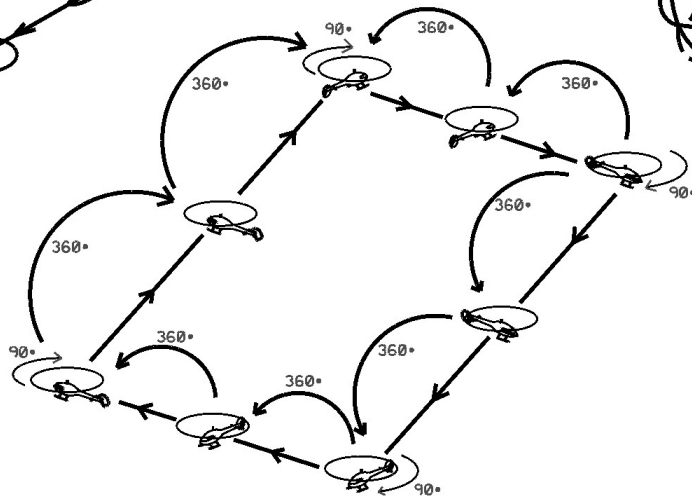

B.9 TIC TOC LOOP



B.10 PIROUETTING WALTZ REVERSAL

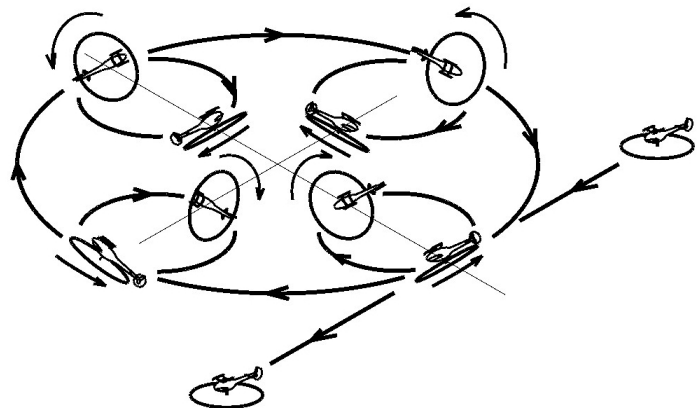
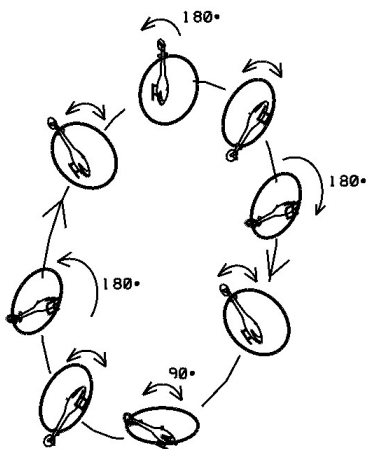

ANNEX 5G

F3N JUDGES GUIDE

5G.1 PURPOSE

The purpose of the F3N judges guide is to provide an accurate description of the major judging criteria to serve as a reference for use in developing a uniformly high standard of judging.

5G.2 PRINCIPLES

The principles of judging a radio controlled model helicopter should be based on the perfection with which the model aircraft performs each set manoeuvre as described in Annex 5F.11.

The main principles used to judge the degree of perfection are:

- 1) Precision of the manoeuvre.
- 2) Smoothness and gracefulness of the manoeuvre.
- 3) Positioning or display of the manoeuvre.
- 4) Size of the manoeuvres relative to each other.

The requirements are listed in order of importance; however, all of them must be met for a manoeuvre to receive a high score or even the maximum of 20 points.

Basically all judging starts with the respective point maximum, from where points are subtracted according to the grading criteria of this guide.

5G.3 ACCURATE AND CONSISTENT JUDGING

The most important aspect of judging is consistency. Each judge must establish his standard and then maintain that standard throughout the competition. It is recommended that the contest director or organiser hold a conference prior to the start of competition to discuss judging so that the standards are as uniform as possible. This should be accomplished with demonstration flights that all judges score simultaneously and privately. After these flights, the defects in each manoeuvre should be discussed by all judges and agreement reached about the severity of the defects. After the competition is started, the individual judges should not alter their standard. Judging accuracy is also very important. Being consistent, whether high or low is not sufficient if the scores awarded do not fairly reflect the performed manoeuvre.

5G.4 CRITERIA FOR JUDGING MANOEUVRES

A description of each set manoeuvre is provided in Annex 5F.11.

Each manoeuvre should be downgraded according to:

- 1) The type of defect.
- 2) The severity of the defect.
- 3) The number of times a defect occurs.
- 4) The positioning of the manoeuvre.
- 5) The size of the manoeuvre relative to other manoeuvres.

A high score should be given only if no major defects are noted and the manoeuvre is accurately positioned. Whenever there is doubt a lower score should be given.

5G.5 ATTITUDE AND FLIGHT PATH

The flight path of the model aircraft (MA) is the trajectory of its centre of gravity. The attitude is the orientation of the rotor disc (RD) in relation to the flight path. All judging should be based on the flight path, but the angle between flight path and RD should not exceed 15° (if not specified otherwise). For higher angles one point per 5° should be subtracted.

5G.6 GRADING CRITERIA FOR MANOEUVRES AND SEGMENTS

The set manoeuvres are composed of segments. The following criteria are furnished to provide the judge with a guide for downgrading deviations from the defined manoeuvre segments.

These segments are: Loop, Roll, horizontal Circle, Turn, Pirouette, Autorotation, Flip, Tic-Toc, Rainbow, Snake and Funnel or parts of them. If a manoeuvre contains several segments of the same type than these have to be similar, e.g. same radii for loops, same roll rates for rolls, same pirouette turning rates etc.

Basically all aerobatic manoeuvres start and end with a straight and level flight of 10 metres minimum length parallel to the judges line (except horizontal eights). All manoeuvres from stationary flight start and end with a hovering of at least 1 second with the model parallel or vertical to the flight line. If one of these segments is missing 2 points should be subtracted.

cont/...

If the orientation of the entire manoeuvre or segments of it is not parallel to the defined line or plane, 1 point per each 5° deviation should be subtracted. If the manoeuvre is not positioned symmetrically to the centreline a downgrade of 1 point per each 5 m should be made.

These two guides (1 point per 5° and 1 point per 5 m) can also be used as a rule of thumb when in doubt and if the downgrades are not defined otherwise.

If the flight altitude changes in horizontal passages a downgrade of 1 point per 2 m for aerobatic and of 1 point per 50 cm for hovering manoeuvres should be made.

In general every severe mistake should also lead to a severe downgrade about 6 points, a medium defect to about 3 points and a small deviation to about one point. Of course the number of mistakes has a big influence too, if a manoeuvre has many severe defects the first one will result in 6 points downgrade, the second one in 4 points, the third in 2 and every further in 1 point. If, in spite of many severe mistakes, the manoeuvre is still recognisable and no parts are missing, the score should not fall below 5 points. If entire segments are missing or the manoeuvre is completely unrecognisable the score must be zero.

5G.6.1 LOOP

A loop must have a constant radius and must be flown in a vertical plane. MA attitude and flight path have to differ to keep the momentum (but less than 15°). The speed of MA should not vary too much and the radius must be smooth and not segmented.

5G.6.2 ROLL

A roll is a rotation about the longitudinal axis of MA. To keep the momentum, for a horizontal roll the longitudinal axis must maintain its angle to a horizontal plane. Start and end of rolls should be crisp and well defined.

5G.6.3 HORIZONTAL CIRCLE

MA speed and circle diameter should be chosen in a way that a circle is flown with less than 20° declination of RD. MA speed and circle diameter have to be constant.

5G.6.4 TURN

A turn is a rotation about the yaw axis after a vertical ascent and just before the complete stop of MA. This rotation must be symmetrical by performing half of it before and the other half after the moment MA comes to a halt. The rotation must be of constant rate without interruptions, with crisp and well defined start and end.

5G.6.5 PIROUETTE

A pirouette is a rotation about the yaw axis. The rotation must be of constant rate without interruptions, with crisp and well defined start and end. Since in F3N pirouettes are not flown stationary but only combined with other manoeuvre segments (like loops, flips and funnels) it is important, that the pirouette does not affect the flight path.

5G.6.6 AUTOROTATION

During this manoeuvre the model should follow an almost straight flight path from the start to the landing on the helipad. This path may be interrupted by a flip or roll but should be resumed after this. If the landing point is not in the circle, a downgrade of 1 point per 1 m distance should be made.

5G.6.7 FLIP

A flip is a rotation about an axis normal to the rotor shaft. Stationary flips need to have a small altitude oscillation (low with RD horizontal, high with RD vertical) which should be less than 50 cm. Lateral deviations of these flips should be downgraded by 1 point per 50 cm.

Travelling flips should not affect the described flight path.

A pushed flip is done by performing the elevator impulse at the transmitter in forward direction. A pulled flip is done by performing the elevator impulse at the transmitter in backward direction.

5G.6.8 TIC-TOC

MA hovers or moves slowly and is rotated using cyclic pitch about 135°. It then rotates its RD in a 90° arc back and forth. A movement of the centre of gravity of less than 2 m for simple tic-tocs or less than 5 m for tic-tocs with pirouettes should not lead to a downgrade, for greater deviations 1 point should be subtracted for the mentioned distances.

5G.6.9 RAINBOW

A rainbow is a semicircle, starting from hovering, with RD always normal to the flight path. The diameter of the semicircle should not be less than 10 m. The start and stop shall be crisp and well defined.

cont/...

5G.6.10 SNAKE

While in fast flight MA follows a wavy line by alternately performing upright and inverted quarter circular segments of equal diameter and length.

During these circular segments the banking must not fall below 45°. A banking of less than 20° means just an array of quarter circles but not a snake and makes the manoeuvre unrecognisable, ie zero points.

5G.6.11 FUNNEL

A funnel is a circle with at least 10 m diameter, performed with a declination of RD of at least 45° from a horizontal plane. MA speed, declination and circle diameter should be constant. A declination of less than 20° means just a horizontal circle but not a funnel and makes the manoeuvre unrecognisable, ie zero points.

5G.6.12 REVERSAL

Cyclic or pirouette reversals must be performed in a way, that the number of rotations in each direction is almost equal. A relation of e.g. 2:1 should lead to a downgrade of 4 points.

If not defined otherwise, the direction of rotation should alter after every 360° rotation.

5G.7 WIND CORRECTION

All manoeuvres are required to be wind corrected in such a way that the shape of the manoeuvre as described in Annex 5F.11 is preserved in the model aircraft's flight path.

To countervail lateral wind (in horizontal or vertical passages) MA must turn its longitudinal axis against the wind. This attitude must not lead to a downgrade as long as the flight path is correct.

Wind parallel to the flight line must be compensated with pitch in vertical passages, an angle between flight path and attitude will in that case lead to a downgrade of 1 point per 5°.

5G.8 CRITERIA FOR JUDGING FREESTYLE FLIGHT AND MUSIC FREESTYLE

For freestyle and music freestyle flights the entire flights will be judged according to the table below:

Criterion	Max Points Freestyle	Max Points Music Freestyle
Difficulty	20 k=3	20 k=2
Harmony	20 k=1	20 k=2.5
Creativity	20 k=1	20 k=2.5
Precision	20 k=3	20 k=2
Safe presentation	20 k=1	20 k=1

For freestyle and music freestyle flights the judges can give maximum 20 points to all criteria. The valence of each criterion is regulated by k-factors.

The scores are given after the flight for all five criteria. It is important, that the scores for each criterion reflect the entire flight, not only some details of the flight.

5G.8.1 DIFFICULTY

This criterion evaluates the level of difficulty of the freestyle flight and music freestyle flight. It is important, that the entire flight is to be judged, not only some highlights. So the score reflects the average level of difficulty. The K-factors of the set manoeuvres may give some reference values for the difficulty, but during the calibration flights and by watching practice flights the judge should get a clear impression of the range of difficulties of possible manoeuvres. Risky manoeuvres should never be mistaken as difficult manoeuvres. Risky manoeuvres must not lead to higher scores for difficulty, but result in a downgrade for safety.

5G.8.2 HARMONY

The combination of the manoeuvres, smooth or flowing transitions between them are the main factors for this criterion. Also the manoeuvres size and dynamic in relation to the model aircrafts performance is of influence. The pace is not of influence here, harmony can be as well demonstrated in dynamic as in gentle sequences.

In Music flights also the harmony between the music and the presentation comes to influence here.

5G.8.3 CREATIVITY

New combinations or new manoeuvres at all will lead to high scores here. Also dynamic and diversified sequences are positive.

There also should be a variety of different tempi in the presentation. Sequences without manoeuvres or repetitions will lead to downgrades.

In Music flights the transformation of musical accents into the performance is of great importance here.

5G.8.4 PRECISION

Precision and recognition of manoeuvres and sequences are evaluated here. The criteria cannot be as strict as for the set manoeuvres as they have to meet an entire flight, but the principles stay the same.

5G.8.5 SAFE PRESENTATION

In addition to the safety rules during the flight(s) (5F.10), the impression of the presentation related to safety is the guide here. If a pilot does not exceed the limit of his skills or flies unsafe in any way (eg too close to himself) a high score can be given here. Flying low (within the rules) by itself is not a reason for downgrade.

5G.8.6 EVALUATION OF THE LEVEL OF DIFFICULTY FOR FREESTYLE SCHEDULE

The following table gives reference values for the estimation of the level of difficulty for both schedules, unlimited and music freestyle.

Aerobic Manoeuvres in Basic Orientations	
3	Examples: Immelmann, short straight passages, loop, loop with full pirouette on top, roll, turn, 540° turn, pirouettes
5	Examples: ½ Cuban eight, long passages, nose-in circle, flips, autorotation
6	Examples: inverted hovering on eyelevel, flip sideward, Cuban eight, flips with hovering stops
6-10	Examples: Horizontal eight, loop sideways, turn with hesitations and/or changes of turning direction, rolling stall turn, autorotation with 180 degree turn, death spiral, knife edge pirouette, speed circle, stationary tictoc, funnel, 4-point roll, multi-point tictoc, Snake
Aerobic Manoeuvres in Several Orientations	
10-15	Aerobic manoeuvres that demonstrate several orientations like inverted, sideways, backwards etc. Examples: Backward Inverted Cuban eight, skids in and out knife edge manoeuvres, snake parallel to flight line and to centerline, different kinds of funnels like waltz
Aerobic Manoeuvres including Piros, Rolls and Flips Etc	
13-18	Aerobic manoeuvres flown in a way where in addition to the CG movement of the main manoeuvre, the model is continuously performing rolls, piros, flips, tictocs or similar. In order to get a high score, many orientations must be shown. Examples: Pirouetting Globe, Chaos, Rolling Globe, Rolling circles, Pirouetting funnels
Aerobic Manoeuvres including Reversals and Transformations	
17-20	Aerobic manoeuvres flown in a way, where piros, rolls, tictocs or other secondary manoeuvres are included/integrated and reversed in an equal and balanced way. Examples: Rolling globe with roll reversals, horizontal circle with continues flips/rolls so that tail boom is always parallel to centerline, Reversing chaos In order to score near maximum, many orientation changes must be displayed, and flight must include many clearly defined manoeuvres.

ANNEX 5H
RADIO CONTROL MODEL HELICOPTERS WORLD CUP RULES

5H.1. Class

The F3C and F3N class are recognised for World Cup competition (Radio Control Model Helicopters).

5H.2. Competitors

All competitors in the specified open international contests are eligible for the World Cup.

5H.3. Contests

Contests included in the World Cup must appear on the FAI Contest Calendar, and must be run according to the FAI Sporting Code. The contests eligible for a World Cup in a particular year, must be nominated before the CIAM Bureau Meeting at the end of the preceding year, and must be included in the FAI Contest Calendar. The selection of the contests should be according to the following guidelines:

- a) a maximum of two contests may be selected for any one country.
- b) each competitor may count only one competition from each country in Europe (taking the better score for any European country in which he has scored in two competitions).
- c) at least three (3) judges have to be appointed for each judges' panel.

5H.4. Points allocation

The points to be allocated to competitors will depend on the number (N) of competitors who have completed at least one flight in the event. A competitor has completed a flight if he registers a score greater than zero (0).

Points are allocated to competitors who have completed at least one flight in the event, according to their placing in the results, as given in the following tables:

a) $N \geq 15$

Placing	1	2	3	4	5	6	...	15	15 and after
Points	15	14	13	12	11	10	...	1	0

A bonus of 6 points is given to the first placed competitor; 4 points to the second placed and 2 points to the third placed.

b) $N < 15$

Placing	1	2	3	4	5	6	...	N
Points	N	N-1	N-2	N-3	N-4	N-5	...	1

A bonus of 3 points is given to the first placed competitor; 2 points to the second placed and 1 points to the third placed.

5H.5. Classification

The World Cup results are determined by considering the total of points obtained by each competitor in the World Cup events. Up to three events may be counted, selecting each competitor's best scores during the year. The winner of the World Cup is the competitor with the greatest total.

In the event of a tie for first, second, and third place, the place will be determined according to the following criteria:

The number of events counted is increased, one at a time, from three until the winner is obtained. If this does not separate the tied competitors, then the winner will be determined by considering the points obtained in the best three events multiplied by the number of competitors who have completed at least one flight in the event. The winner is the one with the greatest total thus calculated.

5H.6. Awards

The winner is awarded the title of winner of the World Cup. Certificates, medals and trophies may be awarded by the CIAM F3 Helicopter sub-committee if available.

5H.7. Organisation

The F3 Helicopter sub-committee shall be responsible for organising the World Cup, and may nominate a responsible person or special sub-committee to collate the results.

5H.8. Communication

The F3 Helicopter’s sub-committee nominated World Cup coordinator must receive the results from each contest in the World Cup, and then calculate and publish the World Cup positions.

These should be distributed to the news agencies and should also be available to any interested bodies or individuals. Final results of the World Cup must be sent to the FAI, National Airsports Controls, and the modelling press.

5H.9. Responsibilities of competition organisers

Competition organisers must propose their event for inclusion in the World Cup, when nominating events for the FAI international Sporting Calendar. The final selection of events from these proposals is made by the CIAM Bureau as defined in paragraph 3. Immediately after the event, the competition organiser must send the results to the World Cup coordinator, within one month as required in the Sporting code B.2.5. Any failure to return scores promptly will be reviewed by the CIAM Bureau when considering the competition calendar for the following year.

5H.10. World Cup Board

A Board of three persons shall be nominated by the CIAM Helicopter Subcommittee Chairman to rule on any issue concerning the implementation of World Cup rules during a year. Any such issue must be submitted in writing to the Helicopter Subcommittee Chairman. The World Cup Board is not entitled to deal with any kind of complaint or protest concerning a single competition, which must be considered by the FAI Jury for that competition.

---oOo---